

FIRE FIGHTER'S GUIDE

1. VIEW NEXT/PREVIOUS ALARM



- Press "NEXT" key once -
- The LCD will display the next alarm.



- Press "PREV" key once -
- The LCD will display the previous alarm.

2. ACKNOWLEDGE DISPLAYED ALARM



- Press "ACK" key once.
- LCD will display "ACKD" for the displayed alarm.
 - If all alarms are acknowledged, the ALARM LED will go steady.

3. RESET DISPLAYED ALARM



- Press "RESET" key once.
- LCD will display "PRESS ACKNOWLEDGE TO CONFIRM RESET".
 - Press the ACK key within 10 seconds to reset the alarm.
 - If the final alarm is reset the LCD will exit FF mode.

4. ISOLATE DISPLAYED ALARM



- Press "ISOLATE" key once.
- LCD will display "PRESS ACKNOWLEDGE TO CONFIRM ISOLATE".
 - Press the ACK key within 10 seconds to isolate the zone.
 - The isolated LED will turn on.
 - If the final alarm is isolated, the LCD will give an option to view isolated alarms.

5. ISOLATE/DE-ISOLATE EXTERNAL BELL



- Press the "EXTERNAL BELL ISOLATE" key once. If the "External Bell Isolate" LED is off it will turn on steady. The External Bell will turn OFF if it is on.
- If the "External Bell Isolate" LED is on, it will turn off. If any un-isolated alarms exist, the External Bell will ring.

6. ISOLATE/DE-ISOLATE WARNING SYSTEM



- Press the "WARNING SYSTEM ISOLATE" key once. If the "Warning System Isolate" LED is off it will turn on steady. The Warning System will turn OFF if it is on.
- If the "Warning System Isolate" LED is on, it will turn off. If any un-isolated alarms exist, the Warning System will sound.

THIS PAGE INTENTIONALLY LEFT BLANK

F3200
AS4428.1 OPERATOR'S MANUAL

F3200 PRODUCT MANUAL
DOCUMENT: LT0251 (A4 Loose)
DOCUMENT: LT0250 (A5 Bound)

Issue 1.01; 29 July 2002

- APPROVALS -

AUSTRALIAN STANDARD AS4428.1 1998
- SSL Listing Number..... afp789
AUSTRALIAN STANDARD AS/NZS3548 1995 Class A

The F3200 Fire Indicator Panel is a product of

Tyco Services Fire & Safety
47 Gilby Road
Mt Waverley
VIC 3149
AUSTRALIA

Tel : +61-3-9538 7220

Fax : +61-3-9538 7255

NOTICE

Information contained in this document is copyright, and shall not be reproduced in any form whatsoever, or its contents disclosed to any third party, without the written consent of Tyco Services Fire & Safety (The Company). Information contained in this document is believed to be accurate and reliable, however the company reserves the right to change the content without prior notice.

INSTALLATION DETAILS

For your reference please complete the following information on the F3200 Fire Indicator Panel supplied.

F3200 FIP SUPPLIED BY	
F3200 FIP INSTALLATION LOCATION	
CONTRACT/JOB NUMBER	
F3200 SERIAL NUMBER	
F3200 SYSTEM AS INSTALLED DRAWING NUMBER	ISSUE:
F3200 SYSTEM PARAMETERS DRAWING NUMBER	ISSUE:
DATE PANEL MANUFACTURED	
DATE PANEL INSTALLED	
DATE PANEL COMMISSIONED	
MAINTENANCE COMPANY	
TELEPHONE	B.H. A.H.
SERVICE CONTACT	
SITE CONTACT OR REGISTERED USER (INCLUDE TITLE)	
COMPANY / ADDRESS	
TELEPHONE	B.H.
F3200 SID NUMBER (IF NETWORKED)	

TABLE OF CONTENTS

Installation Detailsii
End User Liability Disclaimer	vi
Amendments	vii
1 INTRODUCTION	1-1
1.1 SCOPE.....	1-2
1.2 ATTACHMENTS.....	1-3
1.3 ASSOCIATED DOCUMENTATION.....	1-4
1.4 GLOSSARY OF ABBREVIATIONS	1-5
1.5 GLOSSARY OF TERMINOLOGY	1-6
1.6 HOW TO USE THIS MANUAL	1-6
2 SYSTEM DESCRIPTION	2-1
2.1 BASIC PRINCIPLES OF A FIRE ALARM SYSTEM.....	2-2
2.2 F3200 SYSTEM DESCRIPTION.....	2-5
3 SYSTEM SPECIFICATIONS	3-1
3.1 GENERAL.....	3-2
3.2 MECHANICAL SPECIFICATIONS.....	3-6
3.3 ELECTRICAL SPECIFICATIONS	3-7
3.4 INPUT SPECIFICATIONS	3-9
3.5 OUTPUT SPECIFICATIONS	3-10
3.6 SERIAL COMMUNICATIONS	3-11
4 GENERAL DISPLAY & KEYPAD OPERATION	4-1
4.1 INTERPRETING THE LEDS.....	4-2
4.2 RESPONDING TO ALARMS.....	4-6
4.3 DEALING WITH FAULTS.....	4-8
5 OPERATING INSTRUCTIONS - BRIGADE FUNCTIONS	5-1
5.1 INTRODUCTION TO BRIGADE FUNCTIONS.....	5-2
5.2 SILENCING THE INTERNAL SOUNDER	5-4
5.3 ACKNOWLEDGE ZONE IN ALARM.....	5-5

5.4	RESET ACKNOWLEDGED ZONE IN ALARM.....	5-6
5.5	ISOLATE ACKNOWLEDGED ZONE IN ALARM	5-7
5.6	ISOLATING/DE-ISOLATING EXTERNAL BELL.....	5-8
5.7	ISOLATING/DE-ISOLATING WARNING SYSTEM	5-9
5.8	EXITING FF MODE.....	5-10
5.9	RECALLING ALARMS.....	5-11
5.10	BRIGADE FUNCTIONS ON NETWORK SYSTEMS	5-12
6	OPERATING INSTRUCTIONS - SYSTEM FUNCTIONS.....	6-1
6.1	BATTERY TEST & PSU FAULT INHIBIT	6-2
6.2	EXTERNAL BELL TEST	6-4
6.3	WARNING SYSTEM TEST.....	6-5
6.4	LCD/LAMP (LED) TEST.....	6-6
6.5	SYSTEM TEST	6-7
6.6	RECALL SYSTEM FAULTS.....	6-9
6.7	BUZZER TEST.....	6-14
6.8	RECALL HISTORY.....	6-15
6.9	SET SYSTEM TIME.....	6-16
6.10	SET SYSTEM DATE.....	6-16
6.11	ANCILLARY, WARNING SYSTEM, EXTERNAL BELL AND PLANT ISOLATE	6-17
6.12	PRINT FUNCTIONS.....	6-18
6.13	RZDU STATUS DISPLAY	6-19
6.14	RECALL DATABASE CRC.....	6-20
6.15	BRIGADE TEST.....	6-21
6.16	ERROR AND EVENT MESSAGES.....	6-22
7	OPERATING INSTRUCTIONS - ZONE FUNCTIONS.....	7-1
7.1	ZONE ALARM OR FAULT TEST.....	7-2
7.2	ZONE ISOLATE OR DE-ISOLATE	7-4
7.3	ZONE RESET	7-5
7.4	ZONE IN-SITU TEST MODE	7-6
7.5	ZONE STATUS RECALLS.....	7-8

8	OPERATING INSTRUCTIONS - RELAY/OUTPUT FUNCTIONS	8-1
8.1	INTRODUCTION	8-2
8.2	MODULE RELAY STATUS RECALL	8-4
8.3	MODULE RELAY ISOLATE/DE-ISOLATE	8-5
8.4	MODULE RELAY RESET SUPERVISION FAULT	8-6
8.5	MODULE RELAY TEST	8-7
8.6	ANCILLARY RELAY STATUS RECALL	8-8
8.7	ANCILLARY RELAY ISOLATE/DE-ISOLATE	8-9
8.8	ANCILLARY RELAY RESET SUPERVISION FAULT	8-10
8.9	ANCILLARY RELAY TEST	8-11
8.10	OPEN COLLECTOR STATUS RECALL OR TEST	8-12
8.11	WARNING SYSTEM STATUS RECALL	8-13
8.12	EXTERNAL BELL STATUS RECALL	8-14
9	PLACING INTO OPERATION	9-1
9.1	GENERAL	9-2
9.2	POWER-UP	9-2
9.3	COMMISSIONING CHECKLIST	9-3
10	SYSTEM TESTING & MAINTENANCE	10-1
10.1	SYSTEM TESTING & FAULT FINDING	10-2
10.2	MODULE REMOVAL	10-3
10.3	SYSTEM MAINTENANCE	10-4
10.4	PREVENTION OF FALSE ALARMS	10-6
11	NETWORK SYSTEMS	11-1
11.1	INTRODUCTION	11-2
11.2	NDU - NETWORK DISPLAY UNIT	11-4
11.3	LCD TOTALS, LEDS, OUTPUTS & BUZZER OPERATION	11-5
11.4	EXTERNAL BELL/WARNING SYSTEM ISOLATE/SILENCE	11-8
11.5	NETWORK FIP & ZONE NUMBERING	11-10
11.6	SYSTEM FAULT RECALL/NET PANEL STATUS RECALL	11-11
11.7	NETWORK COMMAND RESPONSES & EXCEPTION MESSAGES	11-14

11.8	NETWORK SYSTEM COMMANDS	11-16
11.9	REMOTE RELAY & OPEN COLLECTOR OPERATION & ZONE MAPPING	11-20
11.10	NETWORK ZONE RECALLS & COMMANDS	11-21
11.11	POINT RECALLS & COMMANDS	11-28
	APPENDIX A COMPATIBLE ACTUATING DEVICES (DETECTORS)	A-1

**TYCO SERVICES FIRE & SAFETY
END USER LIABILITY DISCLAIMER**

The F3200 Fire Indicator Panel has a configuration programming facility which may be accessed from the keypad by using a password.

This programming facility allows the user to define in detail the operation of the F3200 System. It is possible for the user to program operational features that prevent the installed FIP from meeting statutory requirements.

Tyco Services Fire & Safety does not accept responsibility for the suitability of the functions programmed by the user.

AS3548 NOTICE

WARNING: This is a Class A product. In a domestic environment this product may cause radio interference in which case the user may be required to take adequate measures.

AMENDMENTS

ISSUE	DATE	AMENDMENT	ECN
1.00	31/10/00	ORIGINAL ISSUE	3041
1.01	29/07/02	Prefix, Appendix A and Pages 2-5, 3-8, 6-10....6-13, 6-17, 8-11, 11-2	3322

1 INTRODUCTION

1.1

SCOPE

The F3200 Fire Indicator Panel (FIP) has an Operator Display Panel with an alphanumeric "Liquid Crystal Display" (LCD) and a keypad. The keypad has numeric keys (0 to 9) and specific control keys (e.g. External Bell Isolate, Reset, etc).

The operator controls the FIP by pressing the appropriate control keys. The FIP, in turn, prompts the operator by displaying messages on the LCD. Where appropriate, the FIP will provide the operator with options, numbered from 1 up. The operator selects the desired option by pressing the appropriate key on the numeric keypad.

Control of the FIP is therefore intuitive to an operator familiar with the basic principles of a fire alarm system.

Such an operator may well perform all desired functions without reference to this manual. This manual is intended as a guide to an unfamiliar operator and a reference for the more experienced operator.

It is recommended that the building owner's representative who is responsible for the fire alarm system, becomes familiar with the FIP operation by practice and by reference to this manual. The unfamiliar operator should learn the basic principles described in Chapter 2, and become familiar with the F3200 system structure and controls.

With appropriate hardware and cabling F3200 panels may be networked to form a system of inter-connected panels and network devices.

This manual describes the operation of both non-networked and networked F3200 panels that comply with AS4428.1, and also describes the operation of the NDU (Network Display Unit) which is essentially a networked F3200 without any alarm zone modules or relay modules. This manual also covers operation of an F3200 panel with an older style AS1603.4 keyboard that has been upgraded to use AS4428.1 compliant software. Some differences in operation are covered in Section 4.2.5. A separate manual, LT0119, covers operating an F3200 panel that complies with AS1603.4.

An NDU may be programmed to operate in "New Zealand mode" for use in New Zealand. New Zealand mode is not available for an F3200 Fire Panel.

Section 1.6 describes how this manual should be used according to the type of panel being operated.

The Manual is structured in chapters as follows:

- Chapter 1: **Introduction**: An introduction to this manual, other F3200 Product manuals and the standards relating to fire alarms.
- Chapter 2: **System Description**: A description of the F3200 system features and functions.
- Chapter 3: **Specifications**: A summary of F3200 system specifications.
- Chapter 4: **General Display & Keypad Operation**: A description of display indications, menu structure and key functions.

SCOPE (CONTINUED)

- Chapter 5: **Operating Instructions - Brigade Functions**; A detailed description of the operation and function of keys for FIRE FIGHTER'S USE provided on the F3200 ("ACK", "RESET", "ISOLATE", "EXTERNAL BELL ISOLATE", "WARNING SYSTEM ISOLATE", "PREV", and "NEXT").
- Chapter 6: **Operating Instructions - System Functions**; A description of the operation and function of keys provided on the F3200 FIP for system testing and operation. For example, System Test, External Bell Test, and Recall History. Also included are the system faults and event messages that can be generated.
- Chapter 7: **Operating Instructions - Zone Functions**; A detailed description of the operation and function of keys provided on the F3200 FIP for zone tests and functions.
- Chapter 8: **Operating Instructions - Relay/Output Functions**; A description of the operation of keys provided on the F3200 FIP for relay and output test and functions.
- Chapter 9: **Placing Into Operation**; A description of how to place a system into operation. Also included is a System Commissioning Checklist.
- Chapter 10: **System Testing & Maintenance**; A description of fault finding, routine testing and system maintenance.
- Chapter 11: **Network System Operation**; Operation of a networked panel or NDU.
- Appendix A: **Compatible Actuating Devices (Detectors)**; A list of detectors approved for use with F3200.

1.2 ATTACHMENTS

A FIRE FIGHTER'S GUIDE is fixed inside the front cover for quick reference in emergencies.

Your installation company should install the following documents inside the panel:

- (a) An "AS INSTALLED" fire detection system diagram and/or summary, describing the installed layout of your F3200 System.
- (b) Other "AS INSTALLED" information, such as System configuration parameters.
- (c) A Maintenance Log-Book.

1.3 ASSOCIATED DOCUMENTATION

1.3.1 PRODUCT RELATED

The following manuals for the F3200 are available:

F3200 Operator's Manual	For F3200 panels that comply with AS1603.4. LT0119 is in A5 bound form. LT0120 is in A4 loose leaf form.
F3200 AS4428.1 Operator's Manual	This manual LT0251 is in A4, loose leaf form. LT0250 is in A5, bound form.
F3200 Technical Manual	Provides technical information for system designers and service staff. Part number LT0121.
F3200 AS4428.1 Installation & Configuration Manual	Provides information for personnel responsible for system design, installation and commissioning. Part number LT0255.
F3200 AS4428.1 Programming Manual	Provides information for panel programmers. Part number LT0256.

1.3.2 STANDARDS RELATED

This manual makes reference to the following Australian Standards:

AS1603.4	Automatic Fire Detection and Alarm Systems Part 1 - Control and Indicating Equipment.
AS4428.1	Automatic Fire Detection and Alarm Systems Part 1 - Control and Indicating Equipment.
AS1670.1	Automatic Fire Detection and Alarm Systems- System Design, Installation and Commissioning.
AS1851.8	Maintenance of Fire Protection Equipment Part 8 - Automatic Fire Detection and Alarm Systems.
AS3548	Noise Emission Standard

This manual makes reference to the following New Zealand standards.

NZS4512	Automatic Fire Alarm Systems in Buildings.
---------	--

1.4 GLOSSARY OF ABBREVIATIONS

The following abbreviations and terminology are used in this manual:

AC	Alternating Current
"ALM"	Display abbreviation for ALARM
AS	Ancillary Supervision
AVF	Alarm Verification, or check alarm.
AZC	Alarm Zone Circuit, commonly referred to as "Detection Zone"
AZF	Alarm Zone Facility, commonly referred to as "GROUP"
CIE	Control and Indicating Equipment
DC	Direct Current
EEPROM	Electrically Erasable Programmable Read Only Memory
EOL	End Of Line device
EPROM	(U.V.) Erasable PROM
F	Flashing LED indicator
FF	Fire Fighter's Facilities, AS4050 (INT)
FIP	Fire Indicator Panel
"FLT"	Display abbreviation for FAULT
FRC	Flat Ribbon Cable
"ISO"	Display abbreviation for ISOLATED
LCD	Liquid Crystal Display
LED	Light Emitting diode (Visual Indicator)
MAF	Master Alarm Facility
MCP	Manual Call Point (break glass switch)
No	Number
O/C	Open Circuit
PCB	Printed Circuit Board
PROM	Programmable Read-Only Memory
PSU	Power Supply Unit
RAM	Random Access Memory
RF	Rapid Flashing LED indicator
RZDU	Remote Zone Display Unit
S/C	Short Circuit
SF	Slow Flashing LED indicator
SID	System Identification Number for a Network Device
VB	Battery Backed Voltage
VBF	Fused Battery Backed Voltage
VNB	Non-Battery Backed Voltage
VNBF	Fused Non-Battery Backed Voltage
8RM	8 Relay Module
8ZM	8 Zone Module

1.5 GLOSSARY OF TERMINOLOGY

The following terminology is used throughout this manual:

Ancillary Equipment	:	Equipment external to Fire Alarm system
Ancillary Relay	:	Relay in FIP which operates Ancillary equipment
Auxiliary Output	:	Output for driving additional LEDs/relays
Baud	:	Bits per second
Brigade	:	Fire Brigade, or any other authority which receives the FIP alarm signals
Control Output	:	Output from FIP to other equipment
Detector	:	Alarm Detection Device
FF Mode	:	The LCD is displaying the alarms list. Limited key entry permitted as per AS4428.1
Global	:	A function that may affect more than one zone
In-Situ	:	A test mode for one person testing of detectors
MAF Zone	:	Any zone, Alarm or Ancillary Relay, that is configured to signal the brigade in the event of an alarm or fault
Mapping	:	Programmable causal relationship between inputs and outputs
Zone	:	Fire searchable area of building

1.6 HOW TO USE THIS MANUAL

This manual describes the operation of both non-networked and networked F3200 panels and also describes the operation of the NDU (Network Display Unit), which is essentially a networked F3200 without any alarm zone modules or relay modules. It also covers operation of an F3200/NDU that has an AS1603.4 compliant keyboard that has been upgraded to use AS4428.1 software (V3.XX). Some differences in operation are covered in Section 4.2.5. Operation of AS1603.4 compliant F3200 panels and NDU is covered in LT0119.

Chapters 1 to 10 apply to non-networked panels, networked panels and NDUs, except that NDUs do not have 8 zone modules or 8 relay modules, and may not have a MAF module. In Chapters 1 to 10 if a particular detail or command differs between non-networked and networked panels, then either the appropriate information for networked systems is also described or the user is directed to Chapter 11.

Chapter 11 contains information specifically for users of networked F3200 panels and NDUs and does not contain any information relevant to users of non-networked F3200s. It is recommended that operators of networked panels or NDUs read the Introductory sections of Chapter 11.

An NDU may be programmed to operate in "New Zealand" mode for use in New Zealand. Any differences in operation between New Zealand mode and Australian mode for the NDU, are described, where applicable, throughout this manual.

2 SYSTEM DESCRIPTION

2.1 BASIC PRINCIPLES OF A FIRE ALARM SYSTEM

2.1.1 DETECTORS & ALARM ZONE FACILITY

A fire alarm system has sensors (electric transducers) which detect the presence of fire. These include heat detectors (thermals), product of combustion detectors (smoke and CO), sprinkler system water flow switches, manual call points (break glass switches), and others.

The building being protected is divided into areas of limited size called zones. The detectors in each zone are connected to an electric circuit called an Alarm Zone Circuit (AZC). The portion of the FIP which controls the AZC is called the Alarm Zone Facility (AZF). In F3200 the 8 Zone Module does this. When a detector detects fire (i.e. operates) it changes the electrical condition on the AZC and the AZF senses this (zone alarm). The detector remains in the operated state (latches) until the AZF temporarily removes the voltages to it (resets it). N.B. some detectors, e.g. flow switches, are non-latching.

As well as sensing when a detector has operated the AZF can sense a fault in the AZC wiring (zone fault), e.g. due to removal of a detector from its base.

The zone isolate function prevents a zone alarm or fault being registered by the Master Alarm Facility (MAF). Refer to Fig 2.1.1.

2.1.2 ALARM VERIFICATION

When programmed (by the installer) to do so, the AZF may perform a verification function on sensed alarms. This Alarm Verification (AVF) functions as follows:

When an AZF senses that a detector has operated, it does not register alarm immediately but delays for a period of time and then resets the detector (typical total delay is 15 seconds). If that, or another detector on the same AZC operates within the next 150 seconds (or similarly programmed period) then the AZF recognises that as a verified alarm, and generates alarm to the MAF.

2.1.3 DISPLAY

There is a display of zone status which allows the operator to see if a particular zone is normal or is in alarm or fault, and if it is isolated.

There is also a separate display of common status which shows if any zone in the system is in alarm, fault, or is isolated.

The display can be a liquid crystal display (LCD) and/or individual LED indicators.

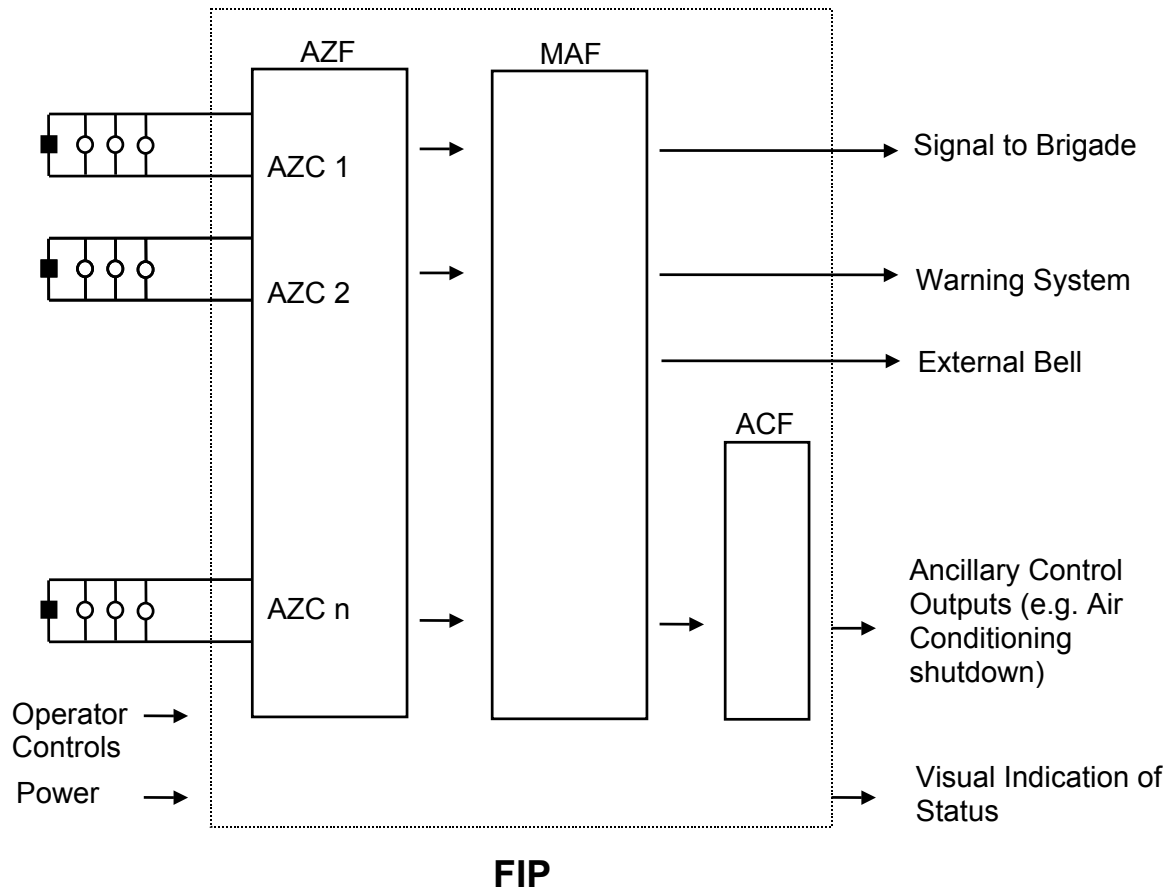

KEY

- AZC = Alarm Zone Circuit
- AZF = Alarm Zone Facility
- MAF = Master Alarm Facility
- ACF = Ancillary Control Facility
- FIP = Fire Indicator Panel
- = End of Line (circuit) Device
- = Detector

FIG 2.1.1
BASIC FIRE ALARM SYSTEM

2.1.4 MASTER ALARM FACILITY

The MAF receives zone status (normal, alarm, fault) and transmits it (via Alarm Signalling Equipment (ASE)) to the Brigade. It also operates the warning system (part of the fire alarm system or a separate warning system) to warn people to evacuate the building, and the External Bell to advise the Fire Brigade of the location of the fire alarm panel.

Individual (or blocks of) zones can be isolated, the External Bell output and Warning System output can be isolated, but the MAF (i.e. Brigade signalling) cannot be isolated.

In F3200 it is possible to have zones which are not "mapped" to the MAF, External Bell, and/or warning system i.e. when in alarm, do not cause a Brigade signal, External Bell or warning system operation.

2.1.5 ANCILLARY CONTROL FACILITY

The ancillary control facility consists of relays (electrically controlled switches) which can be used to switch equipment which is not directly part of the Fire Alarm System. Examples include shutting down air-conditioning plant, returning lifts to a certain floor, and releasing fire stop doors held open by electric door holders.

2.1.6 NETWORKING

A fire panel may be part of a network of devices such as other fire panels, display and control devices, and colour graphic displays.

This builds larger, more flexible systems, and also allows the display and control of the system to be provided at multiple locations throughout a building or group of buildings. It is possible that the brigade signalling would be done by only one panel on the network, with the other panels transmitting alarm/fault, etc, to the common panel for signalling to the brigade.

2.2 F3200 SYSTEM DESCRIPTION

2.2.1 GENERAL

The F3200 is a self-contained, modular, intelligent Fire Indicator Panel (FIP) which performs the functions of the Control and Indicating Equipment (CIE) as specified by the Australian Standard AS4428.1 Automatic Fire Detection and Alarm Systems.

It has a high degree of flexibility and expendability, catering for medium to very large buildings. A single panel may have up to 64 zones and a network system may have up to 64 panels.

2.2.2 DETECTOR CIRCUITS

The F3200 detector circuits cater for a wide range of detectors, including various types which have high alarm current requirements. It also interfaces to:

- Intrinsically safe circuit barriers/isolators (hazardous areas).
- Long line circuits e.g. from a sub-indicator FIP.
- Tamper-proof circuit e.g. for water valve supervision.

A full range of compatible detectors is listed in Appendix A.

2.2.3 DISPLAYS

The primary display of the F3200 is a 2 line by 40 character LCD on which the status messages and prompts are shown. The LCD has backlight illumination which is turned on when there is an alarm or operator interaction. Refer Fig 2.2.1.

Common conditions are displayed on 9 LEDs adjacent to the LCD.

The display panel composed of the LCD common, LEDs and keypad is called the Operator Display panel. The portion within the red border is called the Fire Fighter's Facility (FF). It includes the common status LEDs for ALARM, ISOLATED and FAULT.

As an optional extra, individual zone status (ALARM, ISOLATE and FAULT) can be displayed on LEDs by fitting the appropriate number of 16 Zone LED Display boards.

By default Zone 1 corresponds to the top row of LEDs (3) on the left most display, Zone 2 to the row below it, etc, (top to bottom, left to right).

Display bds may also annunciate Relay status. Alarm LED on <-> relay energised, Isolated LED on <-> relay isolated, Fault LED on <-> relay wiring fault (i.e. supervision fault).

The relay LEDs simply follow the zone LEDs in the same order that they occur in the FIP. For example, a system with 3 x 8 Zone Modules, 2 x 8 Relay Modules, would require 3 Display bds. Relay 1 will be annunciated on the 25th row of LEDs and the last 8 rows will be unused. Mapping zones and relays to LEDs in other patterns is programmable.

The F3200 electronics includes, as standard, an open collector transistor output for each zone which can be used to drive an internal or remote mimic display.

An NDU in New Zealand mode may have an additional 3 system status indicators on the NZ Display Extender board: Fire, Defect, Normal.

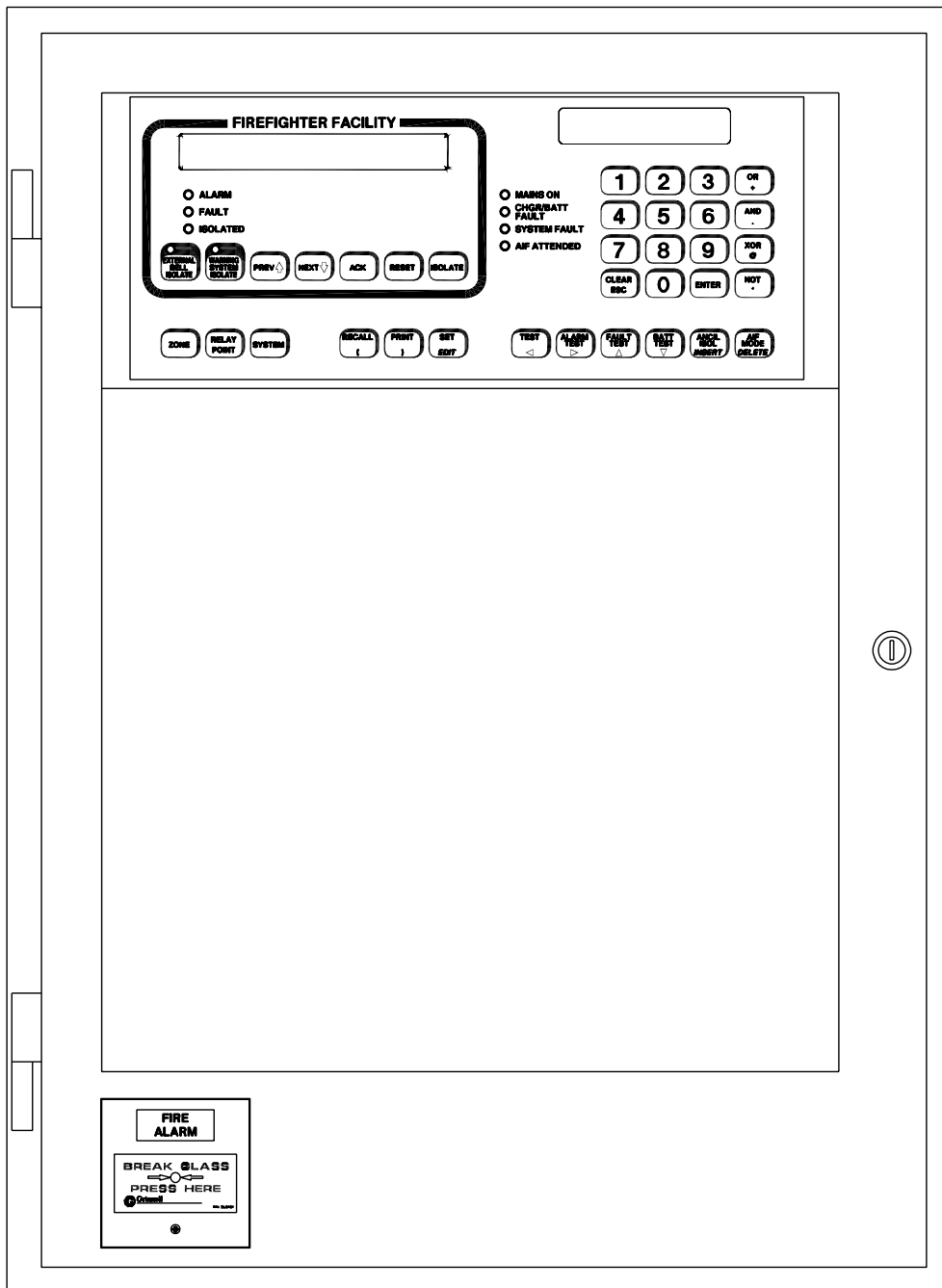

FIG 2.2.1
F3200 - FRONT VIEW

2.2.4 OUTPUTS

The F3200 MAF/PSU Module provides 7 relays as standard. These are used for signalling to the Brigade and for switching alarm bells and ancillary equipment such as door holders or air-conditioning shutdown.

Where more than 7 relays are required, additional sets of 8 are available by fitting an 8 Relay Module.

All outputs are individually programmable with a logic equation of zone and FIP status.

For a networked system it is possible for the brigade signalling to be done by only one panel by combining the status received from the other panels.

2.2.5 POWER SUPPLY

The F3200 has a 3 Amp battery charger as standard. There is adequate room for large batteries. A version with a 6 Amp battery charger is also available.

Fuse protected battery backed and non-battery backed dc voltage supplies are available to power external loads such as bells, illuminated signs, interposing relays or gas release solenoids.

2.2.6 REMOTE DISPLAYS

A serial port is included in the F3200 to provide a 3 or 4 wire link to one or more Remote Display Units (RDUs, with some earlier variants called Remote Zone Display Units RZDUs). Up to 8 replying RDUs may be connected to one F3200. Several versions of F3200 RDU are available.

The most commonly used versions have small, attractive cabinets (flush and surface mounting) not much larger than the F3200 display-keyboard which is fitted on them. They receive power from the F3200 FIP. Other versions look like an F3200 FIP, have their own power supply, and may have LED Display Boards fitted to them.

Additional mimic-only devices can be connected to the RDU output to monitor the F3200 zone status. For example, IO-NET can be used to provide floor mimic panels, AS1668 interfaces or remote outputs for evacuation panels.

For a networked system, an RDU can display (and control) only the zones and relays of the FIP to which the RDU is connected. With appropriate programming, such an RDU could be used to isolate the warning system of that FIP, and hence isolate the warning system across the entire network. Refer to Section 11.4.

2.2.7 LOGGING PRINTER

A serial printer may be connected to F3200 to provide a log of events and operator actions, and also to print the programmed database.

Events which are printed include:

- (i) Zone Events, e.g. Alarm, Fault;
- (ii) Zone Commands, e.g. Reset, Isolate;
- (iii) System events, e.g. communication failures, battery faults, etc.

The printout includes the time and date, the cause of the event (e.g. Zone, Relay, RZDU or FIP), and the event type. Events and commands for zones and relays that have a text name programmed also have the name printed. F3200 is able to store at least 100 events for printing, being the first 100 events to occur.

As events are printed, more events are able to be put into the list. If events cannot be put into the list because it is full, the FIP keeps a count of those events it has had to discard. When the FIP is next able to put more events into the list, it prints out the number of events it had to discard.

For a networked system, with appropriate programming, an F3200 panel (or NDU) may print events and accumulate history for some or all of the other panels on the network.

2.2.8 NETWORKING CAPABILITIES

A number of F3200 fire panels, NDUs (Network Display Unit) and other Vigilant Panel-link compatible devices may be connected together to form a large distributed system. Chapter 11 describes networking operation.

The NDU is essentially a networked F3200 without any 8 zone or 8 relay modules. Two types are available - one a slimline unit without a MAF module and similar to the RDU, the second exactly like an F3200 panel but without any zone or relay modules.

The F3200 System supports the addition of colour graphics display and control terminals on the network. These units can be programmed to show graphical displays on zone alarm or fault conditions. The operator can use function keys or the optional touch screen to generate commands to the F3200 and thus have remote control of it.

2.2.9 CONFIGURATION

An F3200 FIP is configured by the system designer and installation staff to suit a particular customer's requirements.

**** PLEASE NOTE ****

If your building or occupancy requirements change, then the F3200 FIP may require reprogramming, so please consult your installation or maintenance company.

3 SYSTEM SPECIFICATIONS

3.1 GENERAL

3.1.1 FIP PART NUMBER & DESCRIPTION

FP0780, F3200 AS4428 FIP, NO CARDFRAME, 24 ZONE MAX, 1931-95

FP0782, F3200 AS4428 FIP, NO CARDFRAME, 24 ZONE MAX, 1931-95, 6A PSU

Includes: Full size cabinet
Controller/Display with Operator Display & Keypad
MAF/PSU (includes 7 relays, 3A/6A Battery Charger)
1 x 8 Zone Module with standard EOLRs
Modules fit to cabinet rear wall (up to 3 modules max)

FP0781, F3200 AS4428 FIP, C/W CARDFRAME, 64 ZONE MAX, 1931-95

FP0783, F3200 AS4428 FIP, C/W CARDFRAME, 64 ZONE MAX, 1931-95, 6A PSU

Includes: Full size cabinet
Controller/Display with Operator Display & Keypad
MAF/PSU (includes 7 relays, 3A/6A Battery Charger)
Cardframe (can house up to 8 modules)
1 x 8 Zone Module fitted in cardframe
includes standard EOLRs

FP0784, F3200 AS4428 FIP, SMALL CABINET, 1931-71

Includes: Small size cabinet
Controller/Display with Operator Display & Keypad
MAF/PSU (includes 7 relays, 3A Battery Charger)
1 x 8 Zone Module with standard EOLRs
Modules fit to cabinet rear wall (up to 4 modules max)

3.1.2 SYSTEM EXPANSION

Expansion of the base F3200 panel is by adding 8 way modules.

FP0553, F3200 8 ZONE INPUT EXPANSION KIT

Includes: 8 Zone Module, FRC, 8 x EOLR (std)

FP0554, F3200 8 RELAY EXPANSION KIT

Includes: 8 Relay Module, FRC, 8 x Minijump links (for supervision selection)

3.1.3 CONTROLS**KEYPAD**

Type	:	Polyester Membrane
Keypress	:	Buzzer gives short "beep" for valid keypress
Number	:	36
FF Keys	:	EXT.BELL ISOL.; WARNING SYS. ISOL; PREV; NEXT; ACK; RESET; ISOL
4x4 Keypad	:	Digits 0-9; Clear/Esc; Enter; 4 x Logic Keys

Zone Functions	-	Alarm and Fault Test
	-	Isolate, Reset, Recall
	-	In-Situ Test Mode

Ancillary Functions	-	Test, Isolate, Reset, Recall
---------------------	---	------------------------------

Relay Functions	-	Test, Isolate, Reset, Recall
-----------------	---	------------------------------

KEYPAD FUNCTIONS

System Functions	-	Battery Test, Buzzer Test, Display Test
	-	System Test
	-	Bell Test, External Bell Isolate, Warning System Isolate
	-	Recall : Alarms, Faults, Isolates, System Faults, History
	-	Set time and date
	-	Program and view parameters
	-	Print and save database

Brigade Functions	-	Acknowledge Alarms
	-	View alarms (Next & Prev)
	-	Reset acknowledged zone in alarm
	-	Isolate acknowledged zone in alarm
	-	Brigade Test (via menu)

BUZZER (INTERNAL SOUNDER)

Mounted on Controller/Display pcb

Tone Steady	:	Fault, System Fault Unisolated zone (note 1) or relay supervision fault (note 2) Sounder re-sounds 8 hours after silence.
Pulsing 2Hz	:	Unisolated zone alarm (note 1)
Slow Pulse	:	Door closed with Database Write Enabled (Lk7) or zones in alarm test or fault test.
Cadence	:	Zone or In-Situ Test failed (note 3)
Short Pulse	:	Valid keypress
Long Pulse	:	Invalid keypress

CONTROLS (CONTINUED)

Notes:

1. For zones not mapped to MAF (status only) the buzzer does not turn on (dependent also on programming of FF).
2. For relay supervision not mapped to MAF the buzzer does not turn on.
3. Cadence is repeated fast pulses with a pause.

NDU NZ MODE KEYSWITCHES

- Brigade Functions
- Trial Evacuation
 - Silence Alarms
 - Services Restore

3.1.4 DISPLAYS

Standard Operator Display

- Includes : LCD; FF LEDs; System Status LEDs
Panel Size : 19", 4U
FF Type : 3 (common indicators & common controls)
Standard : Complies with AS4428.1
LCD Size : 2 Lines of 40 characters
5.5mm (H) x 3.2mm (W) per character
Site Name : 40 Characters max.
Zone Name : 30 Characters max.
Relay Name : 30 Characters max.
FF LEDs : ALARM (red); ISOLATED (yellow); FAULT (yellow); EXTERNAL BELL ISOLATE (yellow); WARNING SYSTEM ISOLATE (yellow)
System
Status LEDs : MAINS ON (green); CHGR/BATT FAULT (yellow); SYSTEM FAULT (yellow); AIF ATTENDED (yellow)
Internal : Mains On (green), Fuse Blown (yellow) on MAF/PSU pcb.
Status LEDs

Optional Additional LED Display

Requires 1 x ME0060 plus 1 x FZ3031 plus 1-3 x FP0475 as required.

ME0060, MECH ASSY, 1901-79, F4000 RAC, EXT INNER DOOR
(19", 7U, mounts up to 4 of 16 LED Display Bd)

FZ3031 KIT, F3200, 16 ZONE LED DISPLAY, LHS POSITION

FP0475, FP, F4000 DISPLAY EXTENDER KIT, 1901-26

- Includes : 1 x 16 LED Display Bd (16 zone parallel LED display); FRC; Power leads; zone name label.
Format : 7U Parallel LED display mounts directly below the standard 4U LCD.

DISPLAYS (CONTINUED)

Zone LEDs : ALARM (red); FAULT (yellow); ISOLATED (yellow)

Name Space : 10mm x 60mm per zone on paper label.
E.g. 2 lines of 23 characters at 10 per inch.

NDU New Zealand Mode Display Extender Board

Status LEDs: NORMAL (green), DEFECT (yellow), FIRE (Red)

3.1.5 ENVIRONMENTAL

Operating Temperature : -5°C to 45°C (Ambient)

Relative Humidity : 95% maximum @ 40°C (non-condensing)

3.2 MECHANICAL SPECIFICATIONS

CABINET

Style : Wall mounting
Hinged outer door with large window (hinges to left)
Accepts 19" rack mounting equipment
4U Display on hinged inner door (hinges to right)

Construction : Welded steel

Material : 1.6mm mild steel

Size : 750mm (H) x 550mm (W) x 210mm (D) *

* MCP is an additional 20mm.

Finish : Powdercoat BFF-998-CW
Cream Wrinkle
(Iron Phosphate pre-treat)

Weight	Unpackaged	Packaged
FP0780	21kg	24kg
FP0781	25kg	28kg
FP0782	23kg	26kg
FP0783	25kg	29kg
FP0784	17kg	19kg

3.3 ELECTRICAL SPECIFICATIONS

3.3.1 MAINS SUPPLY

Voltage : 240Vac +6% -10%
Current : 0.5A
Frequency : 50Hz

3.3.2 BATTERY CHARGER & PSU

Input Voltage : 31Vac rms
(Transformer sec)

PSU Voltage : 27.3Vdc (nominal at 20°C)

Temperature : -36mV per °C nominal
Compensation

Non-Battery Backed : 28.0 nominal
Voltage

Supervision : Charger High 28.1V nominal
Charger Low 26.6V nominal

Max Charger Current : 3Adc (FP0780/781)
6Adc (FP0782/783)

Max Output Current : 3Adc (FP0780/781)
6Adc (FP0782/783)

3.3.3 BATTERY

Battery Voltage : 24Vdc nominal (2 x 12Vdc)

Compatible Makes : Sonnenschein A200 series
Sonnenschein A300 series
Powersonic PS12 series
Yuasa NP series

Capacity : 6 to 50 Ahr
(dependent on load and configuration)

Space : Up to 220H, 440W, 150D

3.3.4 FUSES

Location : MAF/PSU PCB

<u>Number</u>	<u>Name</u>	<u>Size</u>	<u>Rating</u>	<u>Type</u>
F1	+VBF1	5 x 20mm	2A	Glass Cartridge, Std
F2	+VBF2	5 x 20mm	6A	Glass Cartridge, Std
F3	+VNBF	5 x 20mm	2A	Glass Cartridge, Std
F4	+VE	5 x 20mm	2A	Glass Cartridge, Std
F5	Mains In	5 x 20mm	6A	Glass Cartridge, Std
F7	+VBELLS	5 x 20mm	2A	Glass Cartridge, Std

3.3.5 QUIESCENT & ALARM CURRENTS

At 24Vdc battery supply, nominal currents:

	<u>Quiescent</u>	<u>Alarm (2 Zone)</u>
Base Panel (notes 1 & 2)	130mA	275mA
8 Zone Module		
- all AZCs disabled	4mA	
- all AZCs enabled (notes 2-6)	82mA	97mA
Current per enabled AZC (note 3)	10mA	
8 Relay Module		
- all supervision disabled	4mA	
- all supervision enabled	6mA	
Current per relay on	11mA	
RS485 Communication Board	20mA	

Notes

1. The base panel includes Controller/Display, MAF/PSU and 1 x 8ZM with all AZCs enabled and with EOLRs (2K7 for mode 1 or 2).
2. Quiescent current for enabled AZC is for modes 1 or 2 (standard or high current) and includes the 2K7 EOL, but not the detector current (up to 4mA detector current per AZC).
3. The alarm current shown is for mode 1. Refer to the Technical or Installation manual for detail on other modes.
4. The 8 Zone Modules are supplied from the fused battery supply (+VE) via the 22V regulator which has a maximum rating of 800mA.
5. The 8 Relay Modules are supplied from the fused battery supply.
6. Quiescent and alarm currents do not include external loads e.g. door holders, bells, etc.

3.4 INPUT SPECIFICATIONS

AZCs

Number	:	8 AZCs per 8 Zone Module. 64 max per system.
Voltage	:	20V nominal.
Detector Current	:	4mA max.

Compatible Detectors

Refer to Appendix A.

End of Lines (EOLs)

Mode	EOL
1 Standard	2k7, 5%, 400mW resistor
2 High Current	2k7, 5%, 400mW resistor
3 Low Current	10k, 5%, 400mW resistor
4 Tamper	EOL002Z active EOL
5 Disabled	None

MAF

Door Switch	5V, 0.5mA Unsupervised 4 Way .1" pcb header, J6
MCP	5V, 1mA Supervised 2k7 EOLR 4 Way .1" pcb header, J6

3.5 OUTPUT SPECIFICATIONS

3.5.1 8 ZONE MODULE OUTPUTS

Type	Darlington open collector switch to 0V
Voltage Rating	28.5V max, "off" state 1V max @ 30mA, "on" state, 1.1V max at 100mA
Current Rating	100mA max per O/P, 1A max per FIP
Operation	Programmable
Default	O/C 1 = Zone 1 Alarm; O/C 2 = Zone 2 Alarm, etc.

3.5.2 8 RELAY MODULE OUTPUTS

Form	1 Pole changeover contacts Voltage-free when unsupervised
Rating	30V, 2Adc resistive; 30V, 1Adc inductive
Operation	Programmable
Supervision	Programmable 400 Ohm - 10k Ohm (less than 400 Ohm requires series diode)

3.5.3 MAF/PSU OUTPUTS

Brigade Relays

Number/Type	4 relays, 1 pole changeover contacts
Standby	Normally energised De-energises on battery fail or panel fail or in program mode.
Fault, Isolated, Alarm	Normally de-energised Energise on active state
Rating	30V, 5Adc resistive; 30V, 3Adc inductive
Isolation	1500V rms contact to coil
Anc 1, Anc 2	1 Pole changeover contacts; Voltage-free
Rating	30V, 2Adc resistive; 30V, 1Adc inductive
Operation	Programmable – default is operate on any unisolated alarm
Supervision	Separate terminal, 2 modes, programmable (refer to Technical or Installation manual)

MAF/PSU OUTPUTS (CONTINUED)

Anc 3	1 relay, 2 pole; Link selectable function	
Standard Format	Polarity reversal switched 24Vdc output; 2 terminals, Bells +, -	
Rating	24V, 1.5A Inductive	
Supervision	Programmable, requires diode at each device	
	Number of Circuits	Resistor End of Line (each circuit)
	1	3k3
	2	6k8
	3	10k

3.6	SERIAL COMMUNICATIONS
------------	------------------------------

RZDU Comms

Tx, Rx, 0V 3 Wire (+VBF2 also available). Terminals on MAF/PSU.

Transmission 1200 Baud, Vigilant F4000 RZDU Protocol.

Printer/Programmer Port

Form Pseudo RS232 Rx, Tx, 0V signals only

Transient Protection Allows external wiring

Transmission 9600 Baud (programmable)
ASCII Xon, Xoff Protocol

Termination 4 Way .156" male molex (J1 on Controller/Display).
Standard cables with miniature D connectors available.

THIS PAGE INTENTIONALLY LEFT BLANK

4 GENERAL DISPLAY & KEYPAD OPERATION

4.1 INTERPRETING THE LEDS

4.1.1 OPERATOR DISPLAY LEDS

The description of LED states in this section applies to both non-networked and networked F3200 panels and also to the NDU.

The 9 LEDs on the Operator Display Panel indicate status as follows:

- LED off (unlit) for function off;
- LED on (steady) for function on;
- The ALARM, CHGR/BATT FAULT, EXTERNAL BELL ISOLATE and WARNING SYSTEM ISOLATE LEDs indicate further information by flashing;

All LEDs (except MAINS ON) flash rapidly for 2 seconds on FIP power up, and at 1Hz for LED Test. For Fire Alarm System normal only the MAINS ON LED should be on:

<u>LED</u>	<u>State</u>	<u>Interpretation</u>
ALARM	Flashing	Unacknowledged alarm in FF alarm queue. If there are no unacknowledged alarms; and the alarms total on the base display is not zero (includes isolated zones).
	Steady	
ISOLATED	Steady	The isolates total on the base display is not zero.
FAULT	Steady	The faults total on the base display is not zero.
MAINS ON	Steady	Mains power is present.
CHGR/BATT FAULT	Flashing 2HZ	Battery test failed (battery capacity less than 45%), or battery low, or battery connection fault. Also flashes if mains is failed (after 8 hours).
	Flashing 5HZ	
	Steady	
SYSTEM FAULT	Steady	System Fault, e.g. electronics faulty, internal module unplugged, network fault or all zones isolated.
AIF ATTENDED	Steady	Not implemented.
EXTERNAL BELL ISOLATE	Steady	External Bell output is locally isolated. The External bell output is silenced due to network silence. Refer to Section 11.4.
	Flashing	
WARNING SYSTEM ISOLATE	Steady	Warning system is locally isolated. The Warning System is silenced due to network silence. Refer to Section 11.4.
	Flashing	

4.1.2 16 LED DISPLAY BOARD LEDS

When these boards are fitted they provide 3 LEDs per local zone or module relay.

However any of the LEDs may be controlled by an output logic equation, in which case the behaviour of the LED depends on how it is programmed (which could include conditions received from other panels on a network).

For a zone the 3 LEDs are interpreted as follows:

<u>LED</u>	<u>State</u>	<u>Interpretation</u>
ALM	Flashing	Un-acknowledged alarm. An alarm on a zone not mapped to the FF may or may not flash the alarm LED depending on programming. The alarm LED also flashes for any zone in In-Situ test mode when an alarm is present.
	Steady	Zone in alarm, and acknowledged or isolated.
ISO	Flashing	Zone is in In-Situ mode (walk test).
	Steady	Zone is isolated.
FLT	Steady	Zone is in fault (Independent of mapping and isolation).

NOTE: For an NDU in New Zealand mode zone faults are always non-latching, but the LED indicators are always latching until the zone is reset.

For a module relay the 3 LEDs are interpreted as follows:

<u>LED</u>	<u>State</u>	<u>Interpretation</u>
ALM	Steady	1. If not isolated then the relay is currently energised. 2. If isolated, then the relay is currently de-energised but would be energised if the relay was not isolated.
ISO	Steady	Relay is isolated.
FLT	Steady	Fault in wiring from relay to its ancillary interface device (i.e. supervision fault).

4.1.3 NDU NEW ZEALAND MODE DISPLAY EXTENDER BOARD LEDS

NORMAL LED	-	on steady means normal
	-	off means fire, defect or abnormal condition is present
FIRE LED	-	flashing means alarm present, otherwise off
DEFECT LED	-	normally off
	-	flashing for defect present

4.2 LCD BASE DISPLAY & MENU STRUCTURE

4.2.1 GENERAL

The menu structure of the F3200 takes the form of an inverted tree, with a display screen for every branch. Each screen provides the status being searched for, a message, or a menu of options.

Menu options are normally presented with numbers, and the desired choice is made by pressing the appropriate digit (0 to 9), or by pressing a specific control key e.g. "ACK" (Acknowledge), "RESET", "ALARM TEST", etc. Each choice takes the display down a level in the menu tree.

Generally, control functions result in a message requesting operator confirmation for the function. For example: "Press ACK to reset zone". Pressing "ACK" then initiates the function.

The "CLEAR ESC" (Escape) key is used to return up levels in the menu tree. To get from a function or status message in one branch of the tree to a function or status message in another branch of the tree, generally "CLEAR ESC" must be repeatedly pressed until the menu option gives the choice of the two branches.

If "CLEAR ESC" is pressed enough times, the display returns to the trunk of the tree with one of two screens being displayed. These two screens are termed the base display.

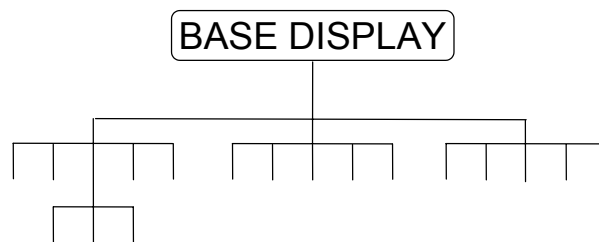

FIG 4.2.1
MENU STRUCTURE

4.2.2 BASE DISPLAY

When the system is normal (no faults, alarms, isolates) then the base display has the site name on the top line, with software version, date and time on the bottom line. For example:

LISBORN DAIRY FACTORY		
F3200 V3.00	08/11/00	2:09:36

BASE DISPLAY (CONTINUED)

When any event has left the FIP in a non-normal state, the base display has the totals of the non-normal conditions under 4 headings. An example of a system with two zones or relays isolated, and one zone or relay fault follows.

Alarms : 0	Isol : 2	Fault : 1	Other : 0
Press the RECALL key to view			

For a networked F3200 or NDU the totals may include totals received from other devices on the network.

The totals are as follows:

Alarms	Includes alarms on all zones including isolated zones.
Isol	Includes all isolated zones and relays (module and ancillary).
Faults	Includes all zone faults, and module/ancillary relay supervision faults (whether isolated or un-isolated).
Others	Includes all system faults, Plant Isolated, network faults and conditions not associated with a zone.

Pressing the RECALL key from the base display gives a menu of options which allow searching for and displaying of off normal zones and system fault conditions. The menu options given are: Alarms, Isolates, Faults and Others, plus FF, History and "more".

Selecting more, (or pressing "RECALL" again) gives a second menu of recall options and repeatedly pressing RECALL cycles around the recall menus.

If an alarm occurs on any un-isolated zone which is mapped to the FF then the display will switch from the base display (or wherever it was) to the FF mode (i.e. display the alarm, refer to Chapter 5). Once all alarms are acknowledged, the display can be returned to the "totals" base display by pressing "CLEAR ESC".

4.2.3 SELECTIVE FUNCTIONS**System Functions**

Menus for system functions can be selected by pressing "RECALL", "SYSTEM", "SET", "TEST" or "PRINT". Direct acting (non-menu) functions are "EXTERNAL BELL ISOL" and "WARNING SYSTEM ISOL". Refer to Chapter 6.

Zone Functions

Zone functions can be selected directly by pressing "ZONE", or indirectly by pressing "RESET", "ISOLATE", "TEST", "ALARM TEST" or "FAULT TEST". Refer to Chapter 7.

Relay Functions

Relay functions can be selected directly by pressing "RELAY POINT", or indirectly by pressing "RESET", "ISOLATE" or "TEST". Refer to Chapter 8.

4.2.4 ZONE NUMBERING

An F3200 panel maps its inputs and outputs to zones so that they may be accessed and controlled over a network.

Zones 1-64	- Alarm zones 1-64
Zones 65-128	- Module relays 1-64
Zones 129-192	- Open collector outputs 1-64
Zone 194	- Ancillary relay 1
Zone 195	- Ancillary relay 2 (External Bell*)
Zone 196	- Ancillary relay 3 (Warning System*)
Zone 197	- Plant isolate
Zone 198	- Warning System
Zone 199	- External Bell

When the status of a relay or open collector is being shown on the LCD, the display shows both the zone number and the relay or open collector number. This mapping scheme means that there are often two ways of doing the same thing. For example, to display the status of module relay 1 it is possible to use either the ZONE key (and select zone 65) or the RELAY key (and select module relay 1).

* By default Zone 195, Ancillary 2, is the External Bell output and Zone 196, Ancillary 3, is the Warning System output. This might not apply if the programming has been changed from the default.

4.2.5 OPERATING AN F3200 WITH AS1603.4 KEYBOARD

The AS4428.1 software (V3.xx) can be installed in an older F3200/NDU that has an AS1603.4 front panel, and the panel is operated as described in this manual but with the following differences.

In normal mode the Bells Isol key is used to perform External Bell Isolate/de-isolate functions and the Bells Isol LED shows the External Bell Isolate status. In New Zealand mode the Bells Isol key and LED correspond to the Warning System and the External Bell is not used.

Warning System isolate/de-isolate functions can be performed by pressing the Ancil Isol key from the base display and selecting the Warning System option from the menu. This menu also displays the current isolate/de-isolate status of the Warning System. If the Warning System is isolated or silenced by network Warning System silence, then the Ancillary Isolate LED will be on steady. The Ancillary Isolate LED is also on steady if any of the local Ancillary or module relays or Plant are isolated.

On a network system, the Warning System and External Bell on a remote panel can be accessed (i.e. isolated, de-isolated, tested) as described in the networking chapter of this manual and the Warning System and External Bell of this panel can be accessed from other panels.

The Brigade Test key may be used to directly perform a brigade test if this is enabled with programming.

If the daily 40 minute battery test is enabled then the battery test resistors on the MAF/PSU module must be removed. The hourly battery test runs for a duration of 60 seconds (instead of 90 seconds) and the manual battery test runs for 60 seconds instead of 40 minutes.

4.3 RESPONDING TO ALARMS

WHEN THE FF ALARM LED INDICATOR IS FLASHING AND THE LCD IS DISPLAYING AN UNACKNOWLEDGED ALARM, PROCEED AS FOLLOWS:

- STEP 1** **DO NOT PRESS "ACK", "RESET", "ISOLATE", "EXT BELL ISOL", OR "WARNING SYSTEM ISOL" KEYS ON THE PANEL** until the Fire Brigade arrives. The "NEXT" key can be pressed to view the next zone alarm in the list if there is more than one alarm present. If the "NEXT" key is pressed, the internal sounder will silence, but the External Bell and warning system will continue to sound.
- STEP 2** INVESTIGATE THE ALARM (if possible by Fire Safety Crew), and implement appropriate fire control and extinguishing measures. The **FIRE SEARCH AREA** (zone) will be indicated by the zone text displayed on the LCD (and by the flashing zone "ALM" LED where the LED display is fitted).
- STEP 3** Evacuate the areas if necessary.
- STEP 4** **ADVISE THE BRIGADE** of real fires and false alarms.
- STEP 5** **KEEP A MEMBER OF THE FIRE SAFETY CREW ON STANDBY** to direct fire fighters to the source(s) of alarm and inform them of measures already taken.
- STEP 6** **RECORD ALL EVENTS IN THE LOG BOOK PROVIDED.**

**** PLEASE NOTE ****

The above procedure should be executed by a trained fire officer, and may need to be modified in accordance with any special conditions applying to the particular F3200 FIP installation.

4.4 DEALING WITH FAULTS

4.4.1 WHAT IS A FAULT?

A fault is any situation which prevents the fire alarm system from performing its functions correctly. Possible faults include defects in wiring to the detectors, faulty detectors, removed detectors, component failures, prolonged mains failure and faulty battery charger.

4.4.2 RESPONDING TO FAULT SIGNALS

For a networked system, refer also to Section 11.6.

When a fault occurs, the fault sounder operates (steady tone). If the fault exists on a zone or relay then the FF "FAULT" LED will be ON. If a system fault exists, the "SYSTEM FAULT" LED will be ON. If a Battery/Charger fault exists, the "CHGR/BATT FAULT" LED will be ON or FLASHING.

The screen will show a message indicating a fault is present and what action to take (usually to call the service company).

The "CLEAR ESC" key or "ACK" key may be pressed in order to silence the panel's fault sounder until a service technician arrives.

If a fault or other off-normal condition exists, the LCD will display the number of Alarms, Faults, Isolates and Other off-normal conditions.

To determine the source of the fault conditions, use the following keypad commands, i.e. press Recall from the base display and select the appropriate menu option:

- Recall Faults
- Recall More, System Faults
- Recall History
- Recall Other

These commands allow an operator to quickly determine the fault condition(s).

Note that the Recall Faults command will show all zones and relays that have faults, regardless of the Isolate status. The Recall History command can help to determine the sequence of fault conditions as the events are ordered chronologically.

**** PLEASE NOTE ****

- (a) Subsequent faults will re-start the fault sounder.
 - (b) RECORD ALL EVENTS IN THE LOG BOOK PROVIDED.
-

5 OPERATING INSTRUCTIONS - BRIGADE FUNCTIONS

5.1 INTRODUCTION TO BRIGADE FUNCTIONS

5.1.1 GENERAL OPERATION & DISPLAY

When an alarm occurs, the FIP switches from the base (or other) display to FF mode and displays the alarm. The keys that can be used are then limited to those within the Firefighters Facility (FF), plus "CLEAR ESC". The FF is the area of the keypad within the red border, as shown in Figure 5.1.

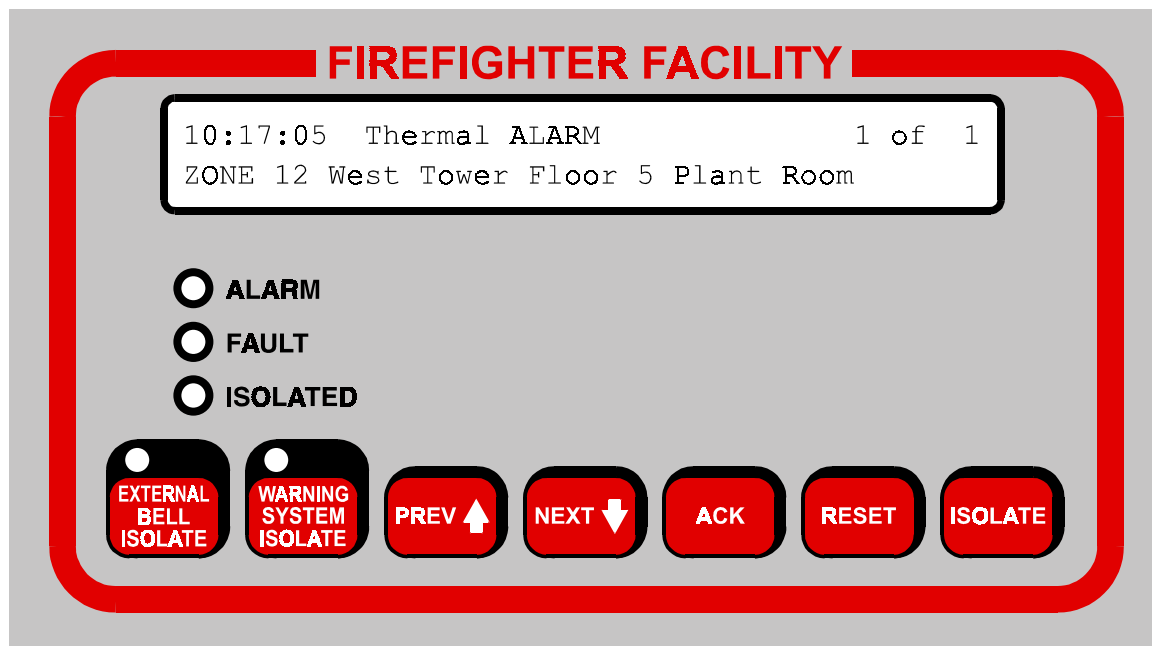

FIG 5.1
EXAMPLE FIREFIGHTER'S FACILITY (FF)

The FF operates as follows:

Each zone alarm is displayed on the LCD and must be individually acknowledged by pressing the "ACK" key when the alarm is displayed. Each alarm can then be reset or isolated by pressing the "RESET" or "ISOLATE" keys respectively, followed by the "ACK" key.

The "NEXT" and "PREV" keys can be used to step around multiple alarms if they exist.

All alarms must be acknowledged before the display can exit from the FF mode.

The "EXTERNAL BELL ISOLATE" key may be used at any time to isolate or de-isolate the External bell.

The "WARNING SYSTEM ISOLATE" key may be used at any time to isolate or de-isolate the warning system.

5.1.2 FF OPERATION

When the FIP is displaying an alarm the LCD display includes the following information:

- (i) The time at which the alarm occurred.
- (ii) The zone alarm type.
- (iii) Whether the alarm is acknowledged or not (Figure 5.1 shows an unacknowledged alarm).
- (iv) The total number of alarms and the sequence number of the currently displayed alarm.
- (v) The zone number and location.
- (vi) For network systems the "AND." or "RELAY/POINT" key may be used to display additional information.

The F3200 FIP maintains a list of alarms in the order in which they occurred. In the absence of operator intervention, the LCD display will show the first alarm. All alarms in the list can be viewed, one by one, by pressing the "NEXT" or "PREV" keys.

Each alarm can be individually acknowledged when it is displayed by pressing the "ACK" key. The text "ACKD" appears on the display whenever an acknowledged alarm is viewed.

Once an alarm has been acknowledged, it can be removed from the alarms list by:

- (i) Pressing the "RESET" key and then the "ACK" key within 10 seconds. The indicated alarm is RESET and removed from the list; or
- (ii) Pressing the "ISOLATE" key and then the "ACK" key within 10 seconds. The indicated alarm is ISOLATED and removed from the list; or
- (iii) The alarm condition being cleared from a non-latching detector on a non-latching zone.

Once all alarms have been acknowledged, stepping past the end (or the beginning) of the alarm list will include any isolated alarms. On pressing "NEXT" at the most recent alarm, or "PREV" at the oldest alarm, a display will show the number of isolated alarms present and a prompt to search for these. Pressing "NEXT" will start a recall of isolated alarms from the beginning (these are shown in numerical order), while "PREV" will start from the end. Pressing "CLEAR/ESC" at this prompt will go back to the first alarm in the alarm list.

After all alarms have been acknowledged, pressing the "CLEAR ESC" key will exit from the FF alarm list display even if there are still zones in alarm. After exiting, the FF alarm list display can be recalled by using the RECALL FF command from the base display.

5.2 SILENCING THE INTERNAL SOUNDER

5.2.1 FUNCTION

Pressing any key will silence the internal sounder, ie, cancel the pulsing alarm tone, steady fault tone, or rapid pulsing test fail tone.

Note that the key pressed will still be processed as if the sounder was not on. Therefore, it is safest to use the "CLEAR ESC" key to silence the sounder and not to use the "ACK" key for faults or other states which are not automatically displayed.

Note: The alarm bell is silenced by the "EXTERNAL BELL ISOLATE" key.

5.2.2 OPERATING SEQUENCE



Press "CLEAR ESC" key once.

- The internal sounder silences.

NOTE:

If a key sequence was being entered, it may be necessary to re-enter number information or the last command as the "CLEAR ESC" key will, in addition to silencing the buzzer, either step back through the menu or clear any number entry sequence that has been started.

If all zone alarms are acknowledged, pressing the "CLEAR ESC" key will result in the LCD exiting FF mode. It can be re-entered by use of the Recall FF command by pressing the "RECALL" key when the base display is shown and selecting the FF option (option 1).

5.3 ACKNOWLEDGE ZONE IN ALARM

5.3.1 FUNCTION

In FF mode, pressing the "ACK" key performs the following functions:

- (a) The displayed alarm is acknowledged.
- (b) The pulsing internal sounder is silenced.
- (c) For a network system:
 - (i) For a local zone an FF acknowledge indication may be sent to other devices on the network;
 - (ii) For a remote zone, an acknowledge command may be sent to the panel originating the alarm.

5.3.2 OPERATING SEQUENCE



Press "ACK" key once:

- Internal sounder will be silenced.
- LCD displays "ACKD" for the currently displayed alarm.
- If there are no more unacknowledged alarms in the system, the ALARM LED goes steady.
- Where fitted, the flashing red "ALM" LED indicator for the zone goes steady.

NOTES:

- (a) Subsequent non-isolated zone ALARMS or FAULTS on the system will re-operate the indicators, and sounder, as appropriate.
- (b) If an unacknowledged FAULT condition existed before the alarm the sounder will still be silenced. However, the FAULT LED will be ON, indicating the presence of a zone or relay fault in the system.
- (c) For a network system, if the alarm being acknowledged is from a zone on a remote panel, then the event in the local FF will be "ACKD" and, depending on programming, an ACK command may be sent to the panel originating the alarm, which in turn may result in the alarm being acknowledged at all devices on the network.
- (d) For an alarm on a local zone, depending on programming, the alarm may be acknowledged at an RZDU which may result in the alarm being acknowledged at the FIP (and hence, for a network system, at other devices on the network).

5.4 RESET ACKNOWLEDGED ZONE IN ALARM

5.4.1 FUNCTION

In FF mode, pressing the "RESET" and then the "ACK" key within 10 seconds performs the following:

- (a) RESETS the indicated zone.
- (b) Silences the internal sounder.
- (c) Aborts zone test if the zone is under test.
- (d) If no more un-isolated alarms exist, the External Bell, warning system, ancillary relays and Brigade Alarm relay turn OFF, if they were ON.
- (e) The acknowledged zone alarm is removed from the alarm list.
- (f) For a network system:
 - (i) For local zones, a return to normal indication may be sent to other network devices to allow the alarm to be removed from their FF list.
 - (ii) For remote zones, depending on programming, a reset command may be sent to the originator of the alarm. The alarm remains in the FF list of the local panel until the originator of the alarm indicates the alarm has been reset.

5.4.2 OPERATING SEQUENCE

Press "RESET" key once:



- LCD displays "Press acknowledge to confirm reset".
- Press the "ACK" key within 10 seconds.
- The displayed zone in the alarm list will be reset.
- If fitted, the red alarm LED indicator for the zone will be turned OFF.
- If there are no more unisolated zones in alarm, then the External Bell, Warning System and Brigade alarm relay will be turned off.
- The internal sounder will be silenced.

NOTES:

- (a) If the alarm condition on the zone input has not been removed, then a new alarm will be generated after the appropriate filtering time delay.
- (b) If a fault condition exists in a zone that also has an alarm condition, FF Reset will not clear the fault. To Reset the fault condition, the Operator must first exit FF mode. (Refer to Sections 5.7 and 7.3).

5.5 ISOLATE ACKNOWLEDGED ZONE IN ALARM

5.5.1 FUNCTION

In FF mode, pressing the "ISOLATE" key and then the "ACK" key within 10 seconds performs the following:

- (a) ISOLATES the indicated zone.
- (b) Silences any internal sounder condition.
- (c) If all alarms are isolated, then the External Bell, Warning System, Brigade alarm relay and any ancillary relays turn off.
- (d) The acknowledged local zone alarm is removed from the alarm list.
- (e) For a network system:
 - (i) For local zones, an isolate condition may be sent to other network devices to allow the alarm to be removed from their FF list.
 - (ii) For remote zones, depending on programming, an isolate command may be sent to the originator of the alarm. The alarm remains in the FF list of the local panel until the originator of the alarm indicates the alarm can be removed.

5.5.2 OPERATING SEQUENCE



Press "ISOLATE" key once:

- The LCD displays "Press acknowledge to confirm isolate".
- Press "ACK" within 10 seconds.
- The displayed zone in the alarm list will be isolated - shown by the corresponding amber "ISOLATED" LED indicator turning ON.
- If all alarms are isolated then the External Bell, Warning System, Brigade Alarm relay and any ancillary relays will turn off.
- The internal sounder, if on, will be silenced.

NOTES:

- (a) Subsequent non-isolated zone ALARMS on the system will re-operate the alarm indications, alarm sounder and local bells.
- (b) Subsequent non-isolated zone FAULTS on the system will operate the fault indication and steady fault sounder.
- (c) To DE-ISOLATE alarm zones, FF mode must be exited and the zone selected for de-isolation. Refer to the Exiting FF mode section in this chapter and the Zone Isolating/De-Isolating section in Chapter 7.

5.6 ISOLATING/DE-ISOLATING EXTERNAL BELL

5.6.1 FUNCTION

For a network system, refer also to Section 11.4.

The isolate status of the External Bell can be changed at any time during FF alarm display by pressing the "EXTERNAL BELL ISOLATE" key. The isolate status of the EXTERNAL BELL is shown on the "EXTERNAL BELL ISOLATE" LED. If it is ON the bell is isolated and will not sound. If the LED is OFF the bells will sound when an un-isolated alarm is present on any zone which is programmed (mapped) to operate the bell.

Isolating the External Bell can serve as a method to silence the bell whilst un-isolated alarms still exist.

De-isolating the External Bell allows the bell to turn on for subsequent alarms occurring, and can serve to immediately turn the bell on again if any un-isolated zone alarm condition exists for zones which are mapped to the bell.

5.6.2 OPERATING SEQUENCE



Press the "EXTERNAL BELL ISOLATE" key once:

- If the bell was un-isolated:
 - The "EXTERNAL BELL ISOLATE" LED turns ON steady.
 - The bell, if ON, turns OFF.
- If the bell was isolated:
 - The "EXTERNAL BELL ISOLATE" LED turns either OFF, or slow flashes.
 - If any un-isolated alarm condition exists on a zone mapped to the External Bell, then the External Bell turns ON, unless the External Bell isolate LED is flashing.

NOTE:

If any subsequent alarm occurs, the External Bell will turn ON only if the External Bell is un-isolated.

5.7 ISOLATING/DE-ISOLATING WARNING SYSTEM

For a network system, refer also to Section 11.4.

The isolate status of the Warning System can be changed at any time during FF alarm display by pressing the "WARNING SYSTEM ISOLATE" key. The isolate status of the WARNING SYSTEM is shown on the "WARNING SYSTEM ISOLATE" LED. If it is ON the Warning System is isolated and will not sound. If the LED is OFF the Warning System will sound when an un-isolated alarm is present on any zone which is programmed (mapped) to operate the Warning System. If the LED is flashing the Warning System is silenced by network silence, or NZ Silence Alarms, and will not sound.

Isolating the Warning System can serve as a method to silence the Warning System whilst un-isolated alarms still exist.

De-isolating the Warning System allows the Warning System to turn on for subsequent alarms occurring, and can serve to immediately turn the Warning System on again if any un-isolated zone alarm condition exists for zones which are mapped to the Warning System.

5.7.1 OPERATING SEQUENCE



Press the "WARNING SYSTEM ISOLATE" key once:

- If the Warning System was un-isolated:
 - The "WARNING SYSTEM ISOLATE" LED turns ON steady.
 - The Warning System, if ON, turns OFF.
- If the Warning System was isolated:
 - The "WARNING SYSTEM ISOLATE" LED turns either off or slow flashes.
 - If any un-isolated alarm condition exists on a zone mapped to the Warning System, then the Warning System turn ON, unless the Warning System isolate LED is flashing.

NOTES:

If subsequent alarm occurs, the Warning System will turn ON only if the Warning System is un-isolated.

If the Warning System is a standalone Evacuation System then isolating the Warning System on the F3200 may not silence the Evacuation System. In this case it is necessary to operate the Evacuation System directly to silence the Warning System.

For an NDU in New Zealand mode the Warning System Isolate LED flashes (at 2HZ) if a Silence Alarms keyswitch has been turned on, and flashes more slowly (at 1HZ) if the Warning System is silenced by network Warning System silence.

5.8 EXITING FF MODE

5.8.1 FUNCTION

While in FF mode, access to all other functions and displays is prevented. On occasion it may be necessary to recall an Isolated Alarm, de-isolate a zone or perform some other function. To do so, FF mode must be exited.

FF mode can be exited only when ALL alarms in the list have been acknowledged.

When FF mode is exited, the LCD shows the base display (totals). At this point, the required functions can be performed e.g. Recall Zone.

5.8.2 OPERATING SEQUENCE



Press the "CLEAR ESC" key once:

- If all alarms are acknowledged, FF mode is exited and the LCD shows the totals.
- If any alarms are NOT acknowledged, the sounder will produce an error tone, and FF mode will not be exited. It is necessary to acknowledge all alarms before FF mode can be exited.

NOTE:

To re-enter FF mode to view the list of alarms, use the Recall FF command sequence. Refer to Section 5.8 Recalling Alarms.

5.9 RECALLING ALARMS

5.9.1 FUNCTION

It is possible for there to be un-isolated, acknowledged alarms present in the FF queue, but the display NOT be in FF mode. The FF can be recalled, and thus put the display into FF mode.

5.9.2 OPERATING SEQUENCE

Press the "CLEAR ESC" key until the base display is shown.

Press the "RECALL" key followed by the "1" key to show the FF alarms list.



The display will start at the first alarm in the alarm list.

If there are no alarms in the FF alarm queue, then the LCD will briefly display "There are no (more) alarms" and revert to the base display.

5.9.3 NON-FF ALARMS

It is possible to have zones not mapped to the FF (i.e. display only zones, e.g. flow switch). These might be displayed on LEDs only.

If such a zone goes into alarm the buzzer will not sound, the LCD will not automatically display the zone, but the FF ALARM LED will be on and the Alarms total will be non-zero. The zone can be found by Recall Alarms (RECALL 4).

It is also possible to have "status only" zones which do not appear in the totals at all. These may only be recalled by pressing "Zone", followed by the zone number.

5.10 BRIGADE FUNCTIONS ON NETWORK SYSTEMS

All of the brigade functions and commands operate exactly as described in Chapter 5, Sections 5.1 to 5.9. I.e. the FF alarm list operation, acknowledging, resetting, or isolating alarms, etc. is the same for network systems, but the following additional details apply to network systems.

FF Alarm List Operation

Depending on programming, the FF alarm list may contain alarms received from other devices on the network.

Local Alarms

Local alarms may always be acknowledged, reset, or isolated. Depending on programming, they may also be acknowledged, reset, or isolated from other network devices or from local RZDUs. With programming, it is possible to inhibit the acceptance of acknowledgements from other network devices or RZDUs and force all alarms to be acknowledged at each device.

Remote Alarms

Alarms received from remote devices may always be locally acknowledged in the local FF alarm list and this will cause an acknowledge command to be sent to the remote device that originated the alarm. Depending on its programming, the remote device may accept this command, and in turn cause all devices on the network to receive an acknowledge indication for the alarm.

Depending on programming, alarms originating from remote devices may also be reset or isolated from the "local" FF display. I.e. when a reset or isolate function is carried out the appropriate command will be sent to the remote device originating the alarm. If this function is disabled, the FF Reset or FF Isolate functions will not send a reset or isolate command to the remote device, and further, the remote device may reject the command with an exception message.

"Point" Key Operation

When a remote alarm is being displayed on the FF display, either the

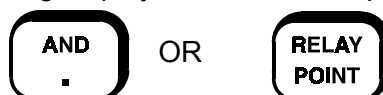

key may be pressed (and held) to show additional information about the source of the alarm.

6 OPERATING INSTRUCTIONS - SYSTEM FUNCTIONS

6.1 BATTERY TEST & PSU FAULT INHIBIT

6.1.1 FUNCTION

For a network system: to test the local battery follow this section; to test the battery at a remote panel refer to Section 11.8.2.

A battery test will disable the battery charger and place the panel load onto the battery for 40 minutes.

6.1.2 OPERATING SEQUENCE

From the base display press the "BATT TEST" key.



- The message "Press ENTER to initiate battery test" will appear. Press the "ENTER" key to initiate the battery test, or "CLEAR ESC" to exit. When the battery test is initiated the display will show "40 minute battery test in progress - press RESET to abort", along with the time (minutes : seconds) that the test has been running for. The charger LED will flash rapidly while the test is in progress.

TO STOP THE BATTERY TEST WHEN RUNNING

- Press the "RESET" key.

THE TEST PASSES

- If at the completion of the test the battery voltage is still within specification, then the test will terminate and the LCD displays "Battery test passed. Pres ACK".
- Press the "ACK" key and the LCD will return to the base display.

THE TEST FAILS

- If during the test a battery low is detected, the test will terminate and the LCD will display "Battery test failed. Press ACK", and a Battery Test Fail event will be logged to history. No fault will be generated.
- Press the "ACK" key to exit back to the base display.
- Perform another battery test after 24 hours and if this fails as well contact your service company.
- If it is known that the battery needs recharging then battery and power supply faults can be inhibited as described in Section 6.1.3.

NOTE:

While the 40 minute battery test is in progress, the keypad and LCD may be used to do other things. Pressing CLEAR will leave the 40 minute battery test running and return to the base display. Pressing BATT TEST from the base display when the battery test is in progress will show the status of the test and the RESET key can be used at this point to terminate the test. If the battery test status screen is not displayed at the time the test

finishes, then the result of the test is not shown on the LCD. However, an event is logged to the history indicating whether the test passed or failed.

6.1.3 PSU FAULT INHIBIT

When a flat battery is connected to a panel, it may take some time before the battery voltage rises above the battery low threshold or for the battery connection test to pass. To allow a service person to clear/inhibit these faults temporarily (for 24 hours) a PSU Fault Inhibit command is provided.

From the base display press:



The message "Press ACK to inhibit PSU faults for 24 hours" will appear. Press the



Key and the message "PSU faults inhibited for 24:00 h:m, Press RESET to cancel" will appear.

After PSU fault inhibit has been enabled, the CLEAR Key can be used to return to the base display.

From the base display, pressing the key sequence:



will show the remaining time that PSU faults will be inhibited for.

When the PSU fault inhibit command is entered any existing battery capacity or battery connection faults are cleared. While the PSU fault inhibit timer is running any battery low conditions or charger faults do not signal fault to the brigade but will still flash the charger LED and appear in the system fault recall.

A fault resulting from 8 hours of mains fail is not cleared by the PSU fault inhibit.

The logic tokens BFT, CGF and BLO return false while the PSU fault timer is running, so any outputs driven by these conditions will be disabled.

When the PSU fault inhibit timer elapses, or is RESET, any battery low, battery connection or charger faults will be signalled to the brigade and logged to history etc, and automatic battery tests will resume at their scheduled times.

6.2 EXTERNAL BELL TEST

6.2.1 FUNCTION

To operate the External Bell Output of this panel for a period of five (5) seconds follow this section.

To test the External Bell Output at a remote panel refer to Section 11.8.5.

6.2.2 OPERATING SEQUENCE

From the base display press:

For a non-network panel:



For a networked panel:



The LCD will show "Press ACK to activate external bell for 5 seconds". Press the "ACK" key to initiate the test.

The External Bell output will then operate for 5 seconds. It can be stopped at any time by pressing the "ACK" key.

6.2.3 NOTES

The action that occurs when an External Bell Test is done depends on the programming of the panel. When an External Bell Test is initiated, the EBT logic token is set true for 5 seconds. Outputs that include EBT in their logic equation will then operate for five seconds. The default programming is for the Ancillary 2 relay to operate when an External Bell Test is done.

6.3 WARNING SYSTEM TEST

6.3.1 FUNCTION

To operate the Warning System Output of this panel for a period of five (5) seconds follow this section.

To test the Warning System Output at a remote panel refer to Section 11.8.6.

6.3.2 OPERATING SEQUENCE

From the base display press:

For a non-network panel:



For a networked panel:



The LCD will show "Press ACK to activate warning system for 5 seconds".

Press the "ACK" key to initiate the test.

The Warning System output will operate for 5 seconds. It can be stopped at any time by pressing the "ACK" key.

6.3.3 NOTES

The action that occurs when an Warning System Test is done depends on the programming of the panel. When an Warning System Test is initiated, the WST logic token is set true for 5 seconds. Outputs that include WST in their logic equation will then operate for five seconds. The default programming is for the Ancillary 3 relay to operate when an Warning System Test is done.

6.4 LCD/LAMP (LED) TEST

6.4.1 FUNCTION

To momentarily flash all LED indicators to visually inspect that they are working correctly, and to test operation of the LCD.

6.4.2 OPERATING SEQUENCE

From the base display, press:

For a non-network panel:



For a networked panel:



A number of different test patterns are displayed on the LCD.

At the same time as the LCD test pattern is shown the LED indicators on the front panel (except the "MAINS ON" LED) will be flashed on for half a second, off for half a second, for 5 seconds.

After the front panel LEDs and LCD have been tested, the zone (and relay) LED display boards will be tested, one board (16 zones) at a time. Each display board will be tested for about 3 seconds and all 48 LEDs on the board will be turned on and off simultaneously with half a second on and half a second off.

The testing of the LED display boards can be terminated by pressing "RESET".

The test can be paused and resumed at a particular display board by using the "ISOLATE" key. The test can be stepped to the next display board by using the "ACK" key. The "ACK" key can be used to step to the next display board when the test is in pause mode.

NOTE: For an NDU in New Zealand mode a Lamp Test can also be started by momentarily shorting the LAMP TEST input on the Display Extender board to 0V.

6.5**SYSTEM TEST****6.5.1 FUNCTION**

For a network system to perform a local system test follow this section; to initiate a system test at a remote panel refer to Section 11.8.1.

The System Test checks the integrity of the system hardware and software.

It applies simulated alarm and fault conditions to each circuit to check that the conditions are detected and processed correctly. It also checks the Controller RAM and EPROM and checks the database EEPROM checksum.

6.5.2 OPERATING SEQUENCE

From the base display, press:



or



A system test cannot be initiated when any of the following conditions are present:

- (a) Database EEPROM checksum error.
- (b) Module configuration fault.
- (c) Battery very low.
- (d) Shift register bus fault.
- (e) Any zone currently being reset or in zone test or In-Situ mode.
- (f) Auto-test currently in progress.

If none of the above conditions are present, a system test will be initiated and the LCD will show "System test in progress - press RESET to abort".

The test may be terminated prematurely at any point by pressing the "RESET" key.

If the test fails for any reason, a test fail cadence will sound on the buzzer and an error message will appear on the display.

The system test will perform memory tests concurrently with circuit fault and alarm tests.

Output logic execution continues to run during system test. If a circuit test fails, the brigade fault relay and "SYSTEM FAULT" LED will turn on.

6.5.3 TEST DESCRIPTION

6.5.3.1 Controller Tests

If the Controller RAM or EPROM test fails, then the Brigade standby relay will de-energise and the "SYSTEM FAULT" LED will turn on but processing of circuit alarms and faults will continue.

If the database EEPROM checksum test fails then all circuit alarm and fault processing will stop and the panel will become in-operational and the standby relay will de-energise. After this fault occurs, it is not possible to perform another system test to re-check the EEPROM database. To recover, do the following.

First, power the panel off and on again which will check the database EEPROM and start processing if the checksum is correct. If the fault does not clear then enter program mode using the "SET" key and entering the password. Then exit program mode which will calculate and save the checksum of the database and then re-check the checksum.

It is advisable to do a printout of the entire database and re-check all of the programmed data.

Alternatively, upload a new database into the F3200 panel by entering program mode and loading a previously saved database.

6.5.3.2 Circuit Tests

Circuit fault tests are done first followed by circuit alarm tests.

The system will NOT test a circuit if any of the following is true:

1. The circuit is disabled.
2. The zone is isolated.
3. The zone is latched in fault or alarm.
4. The zone is a Status Only zone.
5. The circuit input is in B1 band (short circuit) and B1 is programmed to be normal.
6. The 8 Zone Module has been unplugged (partial module configuration fault, see Chapter 6.6.3).

A circuit fault test is done on all odd numbered circuits simultaneously - first (1, 3, 5) taking 4 to 8 seconds, depending on whether any tamper circuits are being tested, followed by all even numbered circuits (2, 4, 6) taking a further 4 to 8 seconds.

After the fault tests, circuit alarm tests are done. All circuit modules are tested simultaneously but only one circuit per module is tested at a time. E.g. if there are 16 zones (two modules) then circuits 1 and 9 will be tested simultaneously, followed by circuits 2 and 10, etc, up to circuits 8 and 16. Each circuit alarm test takes 2 seconds making a total of 16 seconds for the entire circuit alarm tests. If a circuit test fails or an unexpected alarm or fault occurs, then the circuit tests will stop immediately, a test fail cadence will sound on the buzzer and the "BRIGADE FAULT" relay will turn on.

6.6 RECALL SYSTEM FAULTS

6.6.1 FUNCTION

Allows an operator to view on the LCD the current causes of a "SYSTEM FAULT" indication. It also displays the status of any RZDU that has an off-normal condition, including those which do not cause System Fault, and some conditions that don't cause System Fault (e.g. Mains Fail).

6.6.2 OPERATING SEQUENCE

For both networked and non-networked systems, from the base display, press:

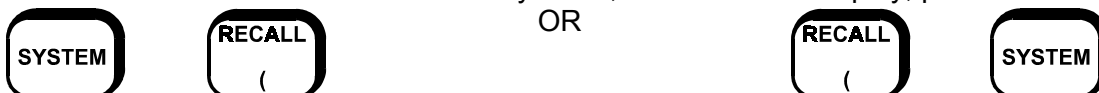

If there are no system faults, a brief message is displayed saying so, and the LCD reverts to the base display.

If a system fault exists, the LCD will display it. To view the next fault, press:



To view the previous fault, press:



6.6.3 LIST OF SYSTEM FAULTS

A system fault recall shows additional network fault information described in Section 11.6. Some of this information also applies to non-networked panels and appears in a system fault recall as a sequence of "pages" with the heading "System Status Summary". If any connected RZDU has an off-normal condition present, then an RZDU status display is included for that RZDU. Refer Section 6.13.

The list of faults which can be displayed by a system fault recall is as follows:

1. Mains fail
When mains fail appears in a system fault recall it indicates that mains is currently failed. When mains has been failed continuously for 8 hours a system fault may be generated depending on programming.
2. EEPROM database checksum error. The panel is in-operational if this fault is present.
3. EEPROM database version error
This fault condition means that the EEPROM database checksum is correct but the database is an old version with a format that cannot be used.

All circuit processing is disabled when this fault is present and the panel is in-operational.

SYSTEM FAULT RECALL FAULT LIST (CONTINUED)

4. Module configuration mismatch
This fault occurs when the number of Zone or Relay Modules installed does not match the programmed number of modules required to be present. The bottom line states processing is enabled or disabled. On detection of a module mismatch processing is disabled and the panel is not operational. A technician can temporarily assign a new configuration so that processing can be re-enabled and use only those modules that are present. This System fault will remain until the correct number of modules is installed and verified as operating correctly.
5. Keypad disconnected. Processing of circuit inputs and alarms continues.
6. LED display board fault
There is a fault with a zone or relay LED display board. This can occur if the wrong number of display boards is installed.
7. LCD display fault
A fault has occurred with the 80 character LCD. This can occur at startup or during an LCD test.
8. EPROM CRC error
A checksum calculation of EPROM memory has failed. This can occur during System and Auto Test.
9. RAM write read fault
A write read test of main RAM has failed. This can occur during System and Auto Test.
10. Charger [high/low/normal] Raw value = [high/low/normal]
This message indicates the battery charger voltage is high, low or normal. The "Raw" high/low/normal value indicates the actual current state of the charger voltage monitoring input. The first high/low/normal value ("Charger") indicates the "signalling" state, where the signalling state is the raw value subject to some filtering delays as follows. A raw charger high (or normal) condition must be present continuously for 5 seconds before becoming the signalling state. A raw charger low condition must be present continuously for 60 seconds before becoming the signalling state, plus a raw charger low condition is ignored for 30 minutes after an automatic or manual battery capacity test. During a battery test, the "raw" value will normally be low because the charger is inhibited, but a charger low will not be signalled for this. If the charger signalling state is high or low, a brigade fault will be signalled (subject to programming of charger fault to signal brigade fault).
11. Fuse blown
12. Clock chip RAM fault
Clock chip RAM is used to store all the isolate data (zone and relay isolate status, etc) plus temporary "board present" assignments. The isolate data and board present data is read from clock chip RAM at startup and this fault means the clock chip RAM has not saved the data correctly and will probably not be read correctly at startup. Try isolating and de-isolating something (e.g. bells) to get the controller to retry writing/reading this RAM.

SYSTEM FAULT RECALL FAULT LIST (CONTINUED)

13. EEPROM write fail
This fault will occur if a failure occurs when writing to EEPROM database memory during program mode.
14. All MAF zones isolated
This fault will occur if all zones (mapped to MAF) are isolated. This can be inhibited with an option in programming.
15. Supply failed
This fault means that both mains has failed and the battery voltage has fallen to 21 volts or below. The standby relay is de-energised and all processing of circuit inputs stops.
16. Output logic exec error nn
An error has occurred with output logic execution. The error number nn has the following meaning:

Note The software produces the following error messages from a series of built-in checks which are performed during the operating of the FIP outputs. It is highly unlikely that such errors will occur. If one does, the operator should inform the service company and have them check it.

1. No equations have been found but some were expected. This indicates a conflict in the information stored in the EEPROM database.
2. Invalid opcode
An invalid token has been encountered in an equation.
3. Range error
This occurs when an out of range value is found such as a timer number greater than 64 or an ancillary relay number greater than 3.
4. Stack error
The execution stack in the RAM has overflowed or underflowed.
5. Link error
An invalid value has been found in a link field in an equation.
6. Invalid MAF output
This indicates a conflict in information stored in the EEPROM database. An equation has been found to control an ancillary or MAF relay but was not expected.
7. NA (New Alarm) function RAM limit exceeded
This indicates too many NA functions have been used in the programming of Output Logic functions.
8. Netvar SID not present
This error occurs if a network variable in the output logic specifies a SID which is not present in the SID list of this panel. Every SID for which netvars are to be accessed must be entered into the SID list of this panel.

SYSTEM FAULT RECALL FAULT LIST (CONTINUED)

9. Zone command range error
An equation to isolate/deisolate or reset a zone or range of zones had an invalid zone number.
10. BEL/BLI logic token present
This indicates the output logic contains the BEL or BLI tokens, which are not valid in V3.XX software. Refer to item 26 below.
17. System/Auto Test circuit test fail
A circuit test failed during System or Auto Test or an unexpected fault or alarm occurred during the test. The Brigade fault relay is turned on when this fault is present. The fault will be cleared by a successful System or Auto Test. Isolating the faulty circuit & performing a System Test should allow the test to pass & clear the fault.
18. Shift register bus fault
This error indicates a fault with the bus connecting the Controller with the MAF/PSU, zone modules and relay modules. It may be caused by a break or short in the flat ribbon cable (e.g. bd unplugged), by temporary noise, or by a circuit board fault.

When this fault occurs all outputs will be held in their current state and all processing of inputs will stop until the fault clears. If the fault does clear, processing of outputs and inputs will resume automatically.
19. RZDU x
This displays the current status of any RZDU which has an off-normal condition. Refer to Section 6.13 for a description.
20. Net msg discard
This occurs only with network systems. The local system discarded a message that was repeatedly sent to another device on the network that did not acknowledge it. To allow other messages to be sent on the network, the unacknowledged msg was discarded. This should occur only in cases of extreme network loading, if the system addressed does not exist or is off line, or if network cables are broken.
21. Net port fault
This indicates a hardware fault with the serial port interfacing to the network. Call the service company.
22. Clock crystal timebase check fail
This error message occurs only at startup and indicates the frequency of the clock chip on the Controller is out of tolerance to the microprocessor. The Controller will restart and try the test again.
23. Clock register write read fail
A test of the Controller time/date clock registers has failed. The Controller will restart and try the test again.
24. Clock chip RAM write read fail
A test of the Controller's clock RAM has failed. The Controller will re-start and try the test again.

SYSTEM FAULT RECALL FAULT LIST (CONTINUED)

25. Shift reg clocking fault
This is the same fault as "Shift register bus fault" above. However, this fault occurs only at startup or on exit from programming mode when the panel is trying to determine what modules are present.
26. Invalid BEL/BLI logic tokens
This message indicates that the output logic in the database in EEPROM contains either the BEL or BLI logic token. These tokens are valid with V2.XX (AS1603) software but not with V3.XX (AS4428) software. This fault can occur if V3.XX software is installed in a panel containing a database created with V2.XX software that has not been updated.
27. Battery is low
This message indicates the battery voltage is low. When PSU faults are inhibited for 24 hours, this message will still appear in a system fault recall if the voltage is low even though it is not creating a system fault.
28. Battery connection fail
This message indicates the battery is not connected, but may occur with the battery connected if the battery is faulty or has a low charge. When PSU faults are inhibited for 24 hours, this message will still appear in a system fault recall if the battery appears to be not connected even though it is not creating a system fault.
29. Battery capacity low
This message indicates an automatic battery test failed, i.e. the battery has a low charge.
30. External defect
This fault occurs only on an NDU in New Zealand mode and indicates the External Defect input on the N.Z. Display Extender board is active.
31. External evac defect
This message indicates the External Evac defect input on the N.Z. Display Extender board is active.
32. Silence alarms
This message indicates the Silence Alarms input on the N.Z. Display Extender board is active.
33. Trial evac
This message indicates the Trial Evac input on the N.Z. Display Extender board is active.
34. Services restore
This message indicates the Services Restore input on the N.Z. Display Extender board is active.
35. Brigade iso/test
This message indicates the Brigade Iso/Test input (dual purpose) on the N.Z. Display Extender board is active.

6.7 BUZZER TEST

6.7.1 FUNCTION

To test the buzzer for both loud and quiet operation. (The buzzer has loud operation for when the FIP door is closed, and quiet for when the door is open).

6.7.2 OPERATING SEQUENCE

From the base display, press:

For a non-network panel:



For a networked panel:



The buzzer will turn on "loud" for 2-3 seconds, followed by "quiet" for 2-3 seconds.

6.8 RECALL HISTORY

6.8.1 FUNCTION

The FIP keeps a list of at least the last 100 events in chronological order. The RECALL HISTORY command allows an operator to view the latest event stored, and to move forwards and backwards through the list. When either end of the list is reached, the LCD automatically shifts to the other end of the list and displays whether the event is the newest (latest) or oldest (earliest). For networked systems the history will include events from other network panels for which event logging is enabled at this panel.

6.8.2 OPERATING SEQUENCE

From the base display, press:



The display will show the most recent history event.

To access the event that occurred before the event displayed, press:



If the "PREV" key is pressed when the event displayed is the oldest event, the LCD will briefly display a message indicating that the event to be displayed is the most recent event and then it displays that event.

To access the event that occurred after the event displayed, press:



If the "NEXT" key is pressed when the event displayed is the most recent event, the LCD will briefly display a message indicating that the event to be displayed is the oldest event on record, and then displays it.

6.9 SET SYSTEM TIME

6.9.1 FUNCTION

Allows an operator to set the time in the real-time clock within the FIP. For network systems, the new time may also be sent on the network to set the time at other devices (depending on programming). In this situation, it is best to set the date first then, the time, and for the time to be entered with the seconds set to 00 and the Enter key pressed at the start of that minute.

6.9.2 OPERATING SEQUENCE

To set the time, press:



The current time is displayed. Enter the new time, in 24 hour format, i.e. the hours value is 00 to 23 where 01 is 1am and 23 is 11pm. Hours, minutes and seconds may be entered. E.g. to set the time to 1:52:40pm, press: "135240 ENTER".

6.10 SET SYSTEM DATE

6.10.1 FUNCTION

Allows an operator to set the date in the real-time clock within the FIP. For network systems, the new date may also be sent on the network to set the date at other devices (depending on programming).

6.10.2 OPERATING SEQUENCE

To set the date, press:



The current date is displayed. Enter the new date.

E.g. To set the date to 21 November 2001, press: "211101 ENTER".

6.11 ANCILLARY, WARNING SYSTEM, EXTERNAL BELL AND PLANT ISOLATE

6.11.1 FUNCTION

To individually isolate or de-isolate local Ancillary 1, Ancillary 2, Ancillary 3, Warning System, External Bell, and the plant, or to provide a global isolate of all allowable local relays.

6.11.2 OPERATING SEQUENCE

From the base display, press:



A menu with 5 options will appear, with a further menu with more options available by pressing:



The current isolate status of each of the relays is shown.

To change the isolate status of any ancillary output use the indicated numeric key 1 to 6.

Ancillary, External Bell, Warning System and Plant Isolate:

Pressing numeric keys 1, 2, 3, 4 and 5 + further menu Key 1 allows isolating or de-isolating of the ancillary relays, External Bell, Warning System, and plant individually. The current isolate state of the selected item will be shown. Press the "ACK" key to change the isolate status. Press the "CLEAR ESC" key to exit without changing. Note each relay can be programmed to have the isolate/deisolate command disabled. Attempting to isolate/deisolate such a relay will display "This relay may not be isolated".

Global Isolate:

Pressing numeric key 2 of the second menu will select a global isolate of allowable ancillary outputs (except External Bells and Warning System). Each ancillary output is programmable as to whether it can be isolated or not.

Note: there is no global de-isolate facility i.e. the relays must be de-isolated individually or in blocks.

Press the "ACK" key followed by the "ENTER" key to initiate the global isolate. Press the "CLEAR ESC" key to exit without doing the global isolate.

NOTE: The PLANT isolate status affects the PLI token in output logic and the "Others" total on the base display. It does not affect the Brigade isolate relay or LED. The PLI token is true if the plant is isolated and false if not isolated. This token may be programmed to disable the ancillary relays, module relays or open collector outputs.

6.12 PRINT FUNCTIONS

6.12.1 FUNCTION

The PRINT key is used from the base display to access functions for printing the history, the system status, the database or to save the database in binary format.

The output can be printed on a printer or captured on a portable computer.

Note that the printer serial port is normally used for printing events. While a print function is in progress, events will not be printed but will be held in a queue of at least 100. Event printing automatically restarts when the printout is finished.

6.12.2 OPERATING SEQUENCE

From the base display press:



A menu with 5 options will be shown. Press a numeric key "1" to "5" to select the appropriate option or press the "CLEAR ESC" key to return to the base display. Options 3 to 5 are not normally used by an operator and require a password. They are described in the F3200 Programmer's manual.

The valid options are:

1. History
This will initiate a printout of the current history from newest to oldest. These events are the same as those shown for Recall History (Section 6.8).
2. System Status
This option can be used to print the current status of the FIP. This includes all zones and relays together with their text names and any off-normal status, plus any system faults.

While a print function is in progress the display will show:

"Print in progress. Press RESET to cancel".

Pressing the "RESET" key will terminate the printout immediately.

Pressing the "CLEAR ESC" key while the printout is in progress will return to the base display and the printout will continue.

6.13 RZDU STATUS DISPLAY

Up to 8 Remote Zone Display Units (RZDU) or Remote LCD Units (RDU) may be connected to an F3200 FIP. These units are monitored for various abnormal conditions, which (in most cases) will generate a System Fault condition if they are detected.

Also each RZDU or RDU may have an MCP mounted on it. This may be mapped (by programming at the F3200) to a zone in the FIP. Operation of the MCP, or a fault on its wiring, will cause an alarm or fault indication on the zone. These are displayed, recalled and logged similarly to other zone alarms and faults, but are also logged as RZDU events.

If an RZDU (or RDU) has any abnormal condition then its status can be viewed on the FIP LCD by initiating a System Fault Recall as described in Section 6.6.

The RZDU display shows the RZDU number plus any of the following conditions if they exist.

BatLo	Battery Voltage Low
ChgrF	Charger Fault
MainF	Mains Fail
BatFl	Battery Voltage Fail
DispF	LED Display Bd Fault
Forgn	Foreign RZDU i.e. particular RZDU not configured in FIP
McpAl	MCP Alarm i.e. on MCP on RZDU
McpFt	MCP Fault i.e. on MCP on RZDU
Scan	Scan Fail i.e. no reply from RZDU (e.g. power off or cable fault)
StstF	Self Test Fail
CMDef	Hardware fault at RDU
SupFt	Relay supervision fault at RDU
Fuse	Fuse blown at RDU

The first three conditions are logged on the printer and displayed, but they do not cause a system fault condition on the FIP.

The other off-normal conditions (except MCP Alarm and Fault) cause a FIP system fault. That is, they turn on the System Fault LED, buzzer and Brigade Fault relay, and add to the "Others" total on the base display.

All conditions are non-latching, i.e. turn off when the condition returns to normal.

6.14 **RECALL DATABASE CRC**

6.14.1 FUNCTION

Allows an operator to view on the LCD the Database CRC and the time and date the database was last changed.

This information can be used as part of an AS1851.8 testing schedule, and to provide for detection of tampering with the system configuration.

For network systems refer to Section 11.8.4.

6.14.2 OPERATING SEQUENCE

For a non-networked system, from the base display press:



The LCD will display the database CRC, and the time and date that the database was last altered.

NOTE: Any changes made to the database will change the numbers displayed in this recall.

Thus, if the database is changed, the new numbers should be recorded in the log book and the service company advised.

6.15 BRIGADE TEST

6.15.1 FUNCTION

The Brigade Test function turns on the Brigade alarm relay (if programmed to) i.e. signals alarm to the Brigade and turns on the "ALARM" LED. For a network system, the brigade signalling may be at a remote panel in which case a command is sent across the network to operate the alarm relay, but the local alarm LED will still turn on after "BRIG TEST" key has been held for 2 seconds.

6.15.2 OPERATING SEQUENCE

Press the "CLEAR ESC" key until the base display is shown.

Press the "TEST" key to select the LOCAL TEST display page, then press and hold the "6" key for at least 2 seconds.



- If so programmed the MAF alarm relay and common "ALARM" LED will turn on.
- "Activated" is shown on the bottom line of the LCD to indicate that the test has been activated.

Release the "6" key.

After a short period:

- The MAF alarm relay will de-activate and the "ALARM" LED will turn off unless there are other alarms present.

NOTE:

That the MAF alarm relay operation of the "Brigade Test" function key can be disabled via system programming. If so disabled, pressing the "TEST", "6" keys will not result in an alarm signal to the brigade, but an event will be logged to the history and printer. However, it is possible for the FIP to be programmed to generate brigade alarm via other means when the Brigade Test is activated. The exact test sequence may be different in this case.

6.16 ERROR AND EVENT MESSAGES

6.16.1 ERROR MESSAGES ON STARTUP OR EXIT FROM PROGRAM MODE

The following messages can be shown on the display during start up or exit from programme mode.

“Shift reg clocking fault”

“Invalid # shift regs.Total # regs=xxx # input regs=xxx”

These messages indicate a hardware fault with the shift register bus that connects the Controller, MAF/PSU, 8 Zone, and 8 Relay modules. The fault could be on the Controller, the interconnecting FRCs or any of the connected boards. Try connecting just the MAF/PSU on its own and with different cables to isolate the problem.

“Shift reg driver fault”

This message indicates a problem with the software driver for the shift register bus.

“Clock crystal timebase check fail”

This message indicates a hardware fault on the Controller.

“Clock chip ram write read fail”

“Clock register write read fail”

“Clock startup fault”

These messages indicate a hardware fault on the Controller.

“Eprom CRC fail”

This message indicates the checksum of the software program code is incorrect. This can be caused by a damaged EPROM or some other hardware fault on the Controller.

6.16.2 ERROR MESSAGES THAT CAN OCCUR ON ENTRY TO PROGRAM MODE

“This database is invalid and should be reinitialised-net dbase in non net panel”

This message is produced on entry to program mode when a database created with networked F3200 or NDU software is used with non-networked software. This is unusable and the database should be re-initialised and reprogrammed.

6.16.3 HISTORY OR PRINTER EVENTS

The following additional events can be recorded in the history or printed as an event on a printer.

SHIFT REG BUS FAULT

This error indicates a fault with the bus connecting the Controller with the MAF/PSU, zone modules and relay modules. It may be caused by a break or short in the flat ribbon cable (e.g. bd unplugged), by temporary noise, or by a circuit board fault.

LCD DDRAM READ FAIL

There is a fault with the RAM on the LCD display module. If the fault is persistent, the LCD module may need replacing. A displays test using the TEST key from the base display) may be able to clear the fault.

HISTORY OR PRINTER EVENTS CONTINUED**ISOLATE RAM FAIL**

Zone isolate data is stored in the clock chip RAM and this event indicates that zone isolate status was not written successfully to the clock chip RAM. The Controller may need replacing.

OP LOGIC ERROR nn

An error has occurred in the execution of output logic and the error number is nn. A list of these errors is given in Chapter 6 Recall System Faults.

CLOCK CHIP FAULT

This event occurs only at startup and indicates a problem with the clock chip. The Controller may need replacing.

NET PORT HW FAULT

This event occurs only for networked panels and indicates that the panel failed to receive an acknowledge to a message it sent on the network. This might occur on busy systems, there is a hardware fault somewhere, or if the device that is programmed to send the acknowledgement is powered down or faulty.

NET MSG DISCARD

This event occurs only for networked panels and indicates that the panel failed to receive an acknowledge to a message it sent on the network. This might occur on busy systems if there is a hardware fault somewhere, or if the device that is programmed to send the acknowledgement is powered down or faulty.

THIS PAGE INTENTIONALLY LEFT BLANK

7 OPERATING INSTRUCTIONS - ZONE FUNCTIONS

7.1 ZONE ALARM OR FAULT TEST

7.1.1 FUNCTION

To test the circuit input of a selected alarm zone or group of zones and to send test alarm signals to the Brigade. Two tests can be performed:

- (a) A fault simulation test, or
- (b) An alarm simulation test.

WARNING: This test performs a true zone test, time delays operate, and, unless the zone is isolated, all outputs operate, including External Bell, Warning System and the Brigade Alarm.

For network systems: to test a local zone follow this section; to test a remote zone refer to Section 11.10.6.

7.1.2 OPERATING SEQUENCE

SUGGESTION: To prevent mapped outputs from operating, ISOLATE the zone(s) first.

- Refer to "Zone Isolate or De-Isolating" section 7.2.

From the base display, press:



OR



where n n is the number of the zone to test.

Alternatively, from the zone status recall display for the zone to be tested, press:



To apply a zone alarm test or zone fault test to the range of zones nn to mm inclusive, from the base display press:



OR



The relevant test signal is applied to the circuits.

Once a circuit has gone into the required test state, the relevant status LED and buzzer are turned on if that zone is not isolated. For alarm test, FF mode will be entered if the zone is mapped to the MAF and the alarm must then be acknowledged.

When the zone status is displayed, the message:

"Test-Fault. Press ACK to stop" or "Test-Alarm. Press ACK to stop"

will be shown. Pressing the "ACK" key stops the test at any point but does not reset the zone. Pressing "RESET" followed by "ACK" will stop the test and reset the zone.

If the circuit does not enter the correct state in response to the test signal then the buzzer sounds its "TEST FAIL" cadence and the LCD displays a test fail message. Resetting the zone will terminate the test.

7.1.3 ABORT ZONE TEST

Press the "ACK" key at any time to stop the ZONE TEST for the displayed zone. This will NOT reset the zone.

Press the "RESET" key followed by "ACK" to stop the zone test and reset the circuit of the displayed zone. It is recommended to always reset a zone at the completion of a zone test.

A zone range reset command will terminate the zone test on each zone being reset (but will leave zone tests running on any zones not being reset).

7.1.4 NOTES

- (a) An Alarm detected on the zone under test when one is not expected (eg during the FAULT test) is processed as a real alarm. Similarly a fault during the ALARM test is processed as a real fault. (After the appropriate first condition tone on the buzzer is silenced, the second condition tone occurs).
- (b) All alarm processing delays (AVF sequences, etc) are still active so the alarm response time will depend on the circuit type and the programmed delays for each circuit.
- (c) An AVF delay sequence initiated by a zone alarm test continues if the zone test is aborted by the "ACK" key before the test has passed (i.e. before the zone goes into alarm). That is, a second alarm test on the same zone within 150 sec will give an instant alarm.
- (d) A zone alarm or fault test will be automatically terminated 5 to 6 minutes after starting.
- (e) It is not possible to start a zone test if the zone is already in test, in In-Situ mode, or if the circuit is disabled.

7.2 ZONE ISOLATE OR DE-ISOLATE

7.2.1 FUNCTION

To isolate or de-isolate a zone or range of zones.

For network systems: to isolate/de-isolate a local zone follow this section; to isolate/de-isolate a remote zone refer to Section 11.10.4.

7.2.2 OPERATING SEQUENCE - SINGLE ZONE

To isolate or de-isolate zone n n, from the base display press:



To isolate the zone shown on a zone status recall display, press:

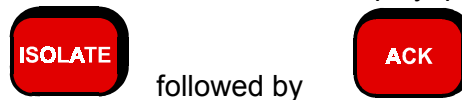

The LCD displays the current isolate status of the zone. Pressing the "ACK" key changes the isolate state. Pressing the "CLEAR ESC" key aborts the Isolate command.

7.2.3 OPERATING SEQUENCE - ZONE RANGE

To isolate or de-isolate a range of zones, from the base display press:



The LCD will display the selected range of zones, i.e. zone n n to zone m m inclusive, plus the options to isolate or de-isolate the range.

To isolate the range of zones, press:



To de-isolate the range of zones, press:



7.2.4 NOTES

- (a) Isolated zone(s) will register and indicate alarm and fault, but are prevented from entering FF mode or operating system outputs.
- (b) If the zone is in In-Situ mode, the zone may still be isolated and de-isolated but will remain in In-Situ mode. A zone which is in In-Situ mode and is isolated will not operate the bells for 2 seconds when an alarm occurs.
- (c) Any zones which are currently in alarm or fault will not be de-isolated by a zone range command and will remain isolated. They must be de-isolated by a single zone de-isolate command.

7.3**ZONE RESET****7.3.1 FUNCTION**

A Zone Reset command performs the following:

- Applies an electronic reset to the AZC to reset latched detectors.
- Clears latched ALARM and FAULT conditions and indications.
- Silences the alarm and fault sounder.
- Cancels any zone test in progress on that zone.
- Returns the Zone from In-Situ mode to normal operation.

A single zone or a continuous range of zones may be reset with a single command.

For network systems: to reset a local zone follow this section; to reset a remote zone or zone range refer to Section 11.10.5.

7.3.2 OPERATING SEQUENCE

To reset one zone only:

To reset zone number n , from the base display press:



From a zone status display, to reset the displayed zone, press:



The LCD will query if this is the zone to be RESET. Press "ACK" to reset, or "CLEAR ESC" to abort.

The zone's red alarm LED and amber fault LED (if fitted) will turn off, and the common alarm and fault LEDs will turn off if there are no other zones in alarm or fault respectively.

To reset a range of zones:

From the base display press:



The LCD will display the range of zones selected. Press the "ACK" key to initiate the reset of zones nn to mm inclusive or press the "CLEAR ESC" key to abort with no reset.

NOTES:

- (a) If a detector or circuit is still in alarm or fault, then after the zone reset delay and the circuit input delay the zone will return to alarm or fault.
- (b) If the amber fault indicator reappears, then isolate the zone and call the service company.

7.4 ZONE IN-SITU TEST MODE

7.4.1 FUNCTION

In-Situ test mode allows testing of all detectors on an Alarm Zone Circuit without the need for a second person resetting alarms at the FIP. It isolates the zone from its outputs, and automatically resets detectors in alarm on the circuits being tested. When the zone goes into alarm the Warning System is operated for 2 seconds, unless the Warning System is isolated, or the zone is not mapped (programmed) to operate the Warning System or the zone is isolated.

For a network system, to In-Situ test a remote zone on another panel, refer to Section 11.10.6. To In-Situ test a local zone, follow this section.

7.4.2 OPERATING SEQUENCE

To put a single zone into In-Situ mode

To In-Situ test Zone nn, from the base display press:



From a zone status display, to In-Situ test the displayed zone press:



To put a range of zones into In-Situ test mode, from the base display press:



Then press the "ACK" key to put the range of zones into In-Situ test mode, or press the "CLEAR ESC" key to abort.

7.4.3 TEST OPERATION

When a zone is put into In-Situ test mode a reset command is applied to the zone so that any latched alarm and faults are cleared.

On operation of a detector (and after the 2 second transient suppression delay) the zone will go into the alarm condition and the Warning System will sound for 2 seconds. After 17 seconds of alarm, usually sufficient time for the detector LED and any remote indicator to be checked, the detector circuit is reset for 6 seconds to allow smoke or heat to clear.

To assist with identification of the detectors wired to the AZC the current voltage band of the AZC is continuously displayed on the LCD. B1 (0-3V) is short circuit, B2 (3-13V) is detector operated, B3 (13-17.5V) is programmable, B4 (17.5-21V) is normal and B5 (21-22V) is open circuit. The zone status (alarm, resetting, etc) is also shown, with a count of the number of alarms detected.

TEST OPERATION (CONTINUED)

When fitted, the zone alarm indicator latches, flashing when an alarm condition is present on the circuit and steady on the removal of the alarm condition.

If a fault occurs on a zone in In-Situ test mode then the Zone Fault LED latches on steady until the end of the test, even if the zone is programmed as non-latching.

Resetting the zone will cancel the In-Situ Test mode for the zone. But as a fusible link detector may have been permanently operated, check that the zone status is normal before resetting. Otherwise a real alarm may be generated.

7.4.4 NOTES

- (a) Multiple zones can be put into In-Situ test mode at the same time.
- (b) If any zone is in In-Situ test mode then it is not possible to perform a System or Auto test.
- (c) All programmed input time delays (e.g. alarm verification) are overridden to allow operation of the detectors to be tested quickly.
- (d) The internal sounder (buzzer) is not operated by a zone in In-Situ test mode.
- (e) All zones in In-Situ test mode will automatically return to normal operation after ONE HOUR from the last alarm received on any such zone or from the last initiation of In-Situ mode on any zone. A reset command will be applied to any such zone but the zone isolate/de-isolate status will not be altered. (Zones should be manually reset and de-isolated for tea breaks, lunch breaks, and when testing is finished).
- (f) A zone may be isolated or de-isolated while it is in In-Situ test mode and will remain in In-Situ test mode. An isolated zone will not operate the Warning System when an alarm occurs.
- (g) When a zone range reset command is used to reset a range of zones all zones in the range will be reset and any which were in In-Situ mode will return to normal operation.
- (h) A zone recall command may be used to step through zones which are in In-Situ mode by selecting the testing option (option 4) from the recall zone display (i.e. "RECALL", "ZONE", "4").
- (i) The outer door of the panel may be closed while one or more zones are in In-Situ mode without causing a slow beeping cadence on the buzzer.

7.5 ZONE STATUS RECALLS

7.5.1 FUNCTION

Allows an operator to recall the status of a specific zone, or to, search for those zones meeting a specified criteria, e.g. in fault or alarm.

For network systems: this section may be used to search for local zones; for searching or displaying remote zones refer to Section 11.10.1.

7.5.2 OPERATING SEQUENCE - ZONE STATUS

To recall the status of zone n n, from the base display press:



To view the status of other zones, press:



to view the status of the next zone, or



to view the status of the previous zone.

Press the "ZONE" key to select a different zone, or press "CLEAR ESC" to return to the base display.

The first line of the LCD displays the zone number and any zone name programmed for that zone.

The second line displays the zone alarm type text for that zone, followed by its status.

The status consists of any of the following:

- normal - the zone is not in alarm or fault
- alarm - the zone is in alarm.
- fault - the zone is in fault.
- isolated - the zone is isolated.
- deisolated - (or deiso) the zone is de-isolated.
- FIP MCP - the FIP MCP maps to this zone.
- Status Only - the zone is a status-only type.
- disabled - the circuit is disabled but the zone may still have the FIP MCP mapped to it. Thus it can still produce alarms and faults, and signal the Brigade but alarms and faults will never be produced by the detector circuit on the AZC module.

OPERATING SEQUENCE – ZONE STATUS (CONTINUED)

If the zone is currently in zone alarm test, zone fault test, In-Situ mode or is being reset, then the zone name on the top line of the display will be replaced by one of the following messages.

"resetting"	- If the zone is currently being reset.
"Test-alarm. Press ACK to stop"	- If a zone alarm test is in progress.
"Test-alarm failed. Press ACK"	- If a zone alarm test has failed.
"Test-fault. Press ACK to stop"	- If a zone fault test is in progress
"Test-fault failed. Press ACK"	- If a zone fault test has failed.
"In-Situ Test Bn"	- If the zone is in In-Situ mode. Bn is one of B1, B2, B3, B4 or B5 depending on the current voltage applied to the circuit input.

7.5.3 OPERATING SEQUENCE - ZONE SEARCHES

The zone search functions allow an operator to query the F3200 for zones meeting specified status criteria, e.g. in alarm.

To start a search, from the base display press:



Then select the option required. Note Status-Only zones do not appear in the alarms, faults or isolate recalls. Valid options are:

"1"	all off normal	Searches for any zones in alarm, fault or isolated, or in zone test or In-Situ mode.
"2"	alarms -	Searches for any zones in alarm, whether or not they are isolated.
"3"	faults -	Searches for any zones in fault, whether or not they are isolated or mapped to MAF.
"4"	testing -	Searches for any zones in zone alarm test, zone fault test or In-Situ mode (independent of zone type and mapping).
"5"	isolated -	Searches for any zones that are isolated or in In-Situ mode.
"6"	status -	Prompts for a zone number and displays the status of that zone as described in Section 7.5.2.

When an option has been selected, the FIP searches for a zone starting from Zone 1 up to the programmed maximum zone that meets the specified criteria.

OPERATING SEQUENCE – ZONE SEARCH (CONTINUED)

Once a zone is found that meets the specified criteria, the LCD display reverts to a zone status display for that zone. When the "NEXT" or "PREV" key is pressed, the search continues for the next or previous zone respectively, that meets the original search criteria.

If no zones matching the criteria are found, the LCD briefly displays a message saying so, and reverts to the base display.

8 OPERATING INSTRUCTIONS - RELAY/OUTPUT FUNCTIONS

8.1 INTRODUCTION

For networked systems local outputs may be accessed as described in this section; outputs on remote panels may be accessed as zones with zone commands as described in Section 11.10.

There are several types of output in the panel whose status may be viewed on the display - module relays, ancillary relays, open collector outputs, External Bell and Warning System.

The functions which can be applied to these outputs include isolate/de-isolate, reset and test. Each of these outputs has a unique zone number but it is not necessary to know the zone number to recall the status of the output.

The status of MAF relays (Alarm, Fault, Isolate and Standby) cannot be viewed on the display and cannot be tested (except Brigade Test tests Alarm).

There are eight open collector outputs on each AZC module and these may be tested (i.e. operated for 5 seconds) but cannot be isolated or reset.

8.1.1 WARNING SYSTEM & EXTERNAL BELL

The purpose of the Warning System is to evacuate people from the building when an alarm occurs. The purpose of the External Bell is to allow the Fire Brigade to locate the fire panel where an alarm has occurred.

The External Bell and Warning System can be isolated and tested, and their status can be recalled. When the Warning System is activated, one or more physical outputs may operate according to output logic programming. By default the Ancillary 3 relay is programmed to operate when the Warning System is activated. By default the Ancillary 2 relay is programmed to operate when the External Bell is activated.

Any of the physical outputs on the panel may be programmed to operate when the Warning System or External Bell is activated.

WARNING SYSTEM OPERATION

By default the Warning System is activated when any non-isolated zone mapped to the Warning System is in alarm, or when the Warning System is tested, or when there is an alarm on a zone that is mapped to the Warning System and is in In-Situ Test mode.

When the Warning System is activated or tested, the physical outputs controlled by the Warning System will operate if the Warning System is not isolated and the physical output itself is not isolated.

When a supervision fault occurs on any of the outputs controlled by the Warning System, the Warning System is also put into fault. When the fault has been fixed, a reset command must be applied to the physical output to clear the latched fault.

By default, the Ancillary 3 Relay cannot be isolated or tested "directly" because these functions are achieved with a Warning System Test or isolate command. However, this can be changed with programming.

For an NDU in New Zealand mode the Warning System is activated when a Trial Evacuation Keyswitch is operated and the Warning System is inhibited when a Silence Alarms Keyswitch is operated.

EXTERNAL BELL OPERATION

By default the External Bell is activated when any non-isolated Zone mapped to the External Bell is in alarm or when the External Bell is tested.

When the External Bell is activated or tested, the physical outputs controlled by the External Bell will operate if the External Bell is not isolated and the physical output itself is not isolated.

When a supervision fault occurs on any of the outputs controlled by the External Bell, the External Bell is also put into fault. When the fault has been fixed, a reset command must be applied to the physical output to clear the latched fault.

By default, the Ancillary 2 output cannot be isolated or tested "directly" because these functions are achieved with an External Bell isolate or test command.

However, this can be changed with programming.

8.1.2 MODULE RELAYS

Relays on the 8 Relay Module are controlled by output logic that has been specifically programmed. They may also be activated for 5 seconds during a relay test.

8.1.3 ANCILLARY RELAYS

The Ancillary relays 1, 2 and 3 are located on the MAF board. Each of these relays is controlled by an output logic equation.

For the Ancillary 1 relay, there is no default equation but the relay will operate when any non isolated zone mapped to the Ancillary 1 relay is in alarm. If an output logic equation is programmed for the Ancillary 1 relay, then the relay operates according to the equation and ignores any zones specifically mapped to it – i.e. an alarm on a zone mapped to the Ancillary 1 relay does not cause the Ancillary 1 relay to operate when the relay is controlled by an output logic equation (this saves having to de-map all zones from the Ancillary 1 relay).

By default, all alarm zones are programmed to map to the Ancillary 1 relay, the External Bell (Ancillary 2 relay) and the Warning System (Ancillary 3 relay).

8.1.4 OPEN COLLECTOR OUTPUTS

There are 8 open collector outputs on each 8 Zone Module, i.e. one open collector output for each alarm zone circuit. Each output may be controlled by a logic equation.

If an open collector output has no logic equation then the output will be on whenever the corresponding zone is in alarm and is not isolated.

8.2 MODULE RELAY STATUS RECALL

8.2.1 FUNCTION

To display the status of a local module relay.

For network systems, to display the status of a relay on a remote panel you need to use the zone number associated with the relay and a zone recall command. Refer to Section 11.10.

8.2.2 OPERATING SEQUENCE

To display the status of a local module relay n n, from the base display press:



to select module relays, then press:



The status display will show the relay number, zone number and name on the top line and information on the bottom line as follows:

deactivated	- if the relay is de-energised
activated	- if the relay is energised
normal	- no supervision fault
fault	- supervision fault
open circuit	- supervision fault
short circuit	- supervision fault
isolated	
de-isolated	
unsupervised	

The "RESET", "ISOLATE" and "TEST" keys may be used from this display and "NEXT" and "PREV" may be used to step through the module relays.

8.3 MODULE RELAY ISOLATE/DE-ISOLATE

8.3.1 FUNCTION

To isolate or de-isolate a single module relay or continuous range of module relays.

Whenever a relay is isolated the relay will always be de-energised. A supervision fault on an isolated relay mapped to the MAF will NOT activate the brigade fault relay.

For network systems to isolate a relay on a remote panel, use a zone command - refer to Section 11.10.

8.3.2 OPERATING SEQUENCE

To isolate or de-isolate a local module relay or range of relays, from the base display press:



To isolate/de-isolate module relay n n press:



To isolate/de-isolate the range of module relays n n to m m press:



Then press numeric key "1" to isolate relays n n to m m or numeric key "2" to de-isolate them, or press "CLEAR ESC" to abort.

8.3.3 NOTES

Depending on programming, an isolate command may not be allowed on particular relays, in which case the message "This relay may not be isolated" will appear when an attempt is made to isolate it.

8.4 MODULE RELAY RESET SUPERVISION FAULT

8.4.1 FUNCTION

To reset a latched supervision fault on a single module relay or a continuous range of relays.

Each module relay may be programmed to be latching/non latching and mapped/not mapped to the MAF. If a module relay is programmed as latching then when a supervision fault occurs on the output wiring the fault will remain after the supervision fault is physically cleared.

For network systems, to reset a relay on a remote panel use a zone reset command - refer to Section 11.10.

8.4.2 OPERATING SEQUENCE

To reset a local module relay, from the base display press:



to select module relays, then press either:



to reset the range of relays nn to mm inclusive.

Press  To confirm the reset, or "CLEAR ESC" to abort.

If the fault is still physically present on the output wiring then the relay will remain latched in fault.

8.5 MODULE RELAY TEST

8.5.1 FUNCTION

To briefly turn on a relay output (i.e. for five seconds).



If the relay is isolated the test command will not energise the relay.

If the relay is already energised (because an output logic equation requires it to be on) then it will remain energised and is not affected by the test.

For network systems, to test a relay on a remote panel use a zone operate test command - refer to section 11.10.

8.5.2 OPERATING SEQUENCE

To test a local module relay, from the base display press:

  to select module relays, then press

   to test relay nn or

to test the range of relays nn to mm inclusive.

Press  to apply the test, or "CLEAR ESC" to abort.

The relays will be energised (if not isolated) for five seconds, or until "ACK" is pressed, and then de-energised.

8.5.3 NOTES

Depending on programming, a test command may not be allowed on particular relays, in which case, the message "This relay may not be tested" will appear when an attempt is made to test it.

8.6 ANCILLARY RELAY STATUS RECALL

8.6.1 FUNCTION

To display the status of a local ancillary relay. For network systems, to display the status of an ancillary relay on a remote panel use a zone recall command. Refer Section 11.10.

8.6.2 OPERATING SEQUENCE

To display the status of a local ancillary relay, from the base display press:



to select ancillary relays

then press numeric key "1", "2" or "3" followed by the ENTER key to select the desired ancillary relay.

The programmed name for the relay will be show on the top line and the status of the relay will be shown on the bottom line of the display as follows:

deactivated	- if the relay is de-energised
activated	- if the relay is energised
normal	- no supervision fault
fault	- supervision fault
open circuit	- supervision fault
short circuit	- supervision fault
isolated	
de-isolated	
unsupervised	

The "RESET", "ISOLATE" and "TEST" keys may be used from this display and "NEXT" and "PREV" may be used to step through the three ancillary relays.

8.7 ANCILLARY RELAY ISOLATE/DE-ISOLATE

8.7.1 FUNCTION

The local Ancillary 1, Ancillary 2, and Ancillary 3 relays may be individually isolated/de-isolated (depending on programming).

This may be done by using the "ANCIL ISOL" key (described in section 6.11) or from an ancillary relay status display as follows.

For network systems to isolate/de-isolate an ancillary relay on a remote panel, use a zone isolate/de-isolate command. Refer to Section 11.10.

8.7.2 OPERATING SEQUENCE

To isolate/de-isolate a local ancillary relay, from the base display press:



to select ancillary relays,

then press numeric key "1", "2" or "3" followed by the ENTER key to select the desired ancillary relay. Then press:



to change the current isolate status of the relay.

8.7.3 NOTES

De-isolating an ancillary relay may cause the relay to turn on and isolating a relay will cause the relay to turn off if it was on.

De-isolating a relay may cause the Brigade Fault relay to turn on if there is a latched supervision fault on the ancillary relay and the ancillary relay is mapped to the MAF.

Depending on programming, an isolate command may not be allowed on particular relays. In which case the message "This relay may not be isolated" will appear when an attempt is made to isolate it.

8.8 ANCILLARY RELAY RESET SUPERVISION FAULT

8.8.1 FUNCTION

To reset a latched supervision fault on a local ancillary relay.

For network systems, to reset a latched supervision fault on an ancillary relay on a remote panel, use a zone reset command. Refer Section 11.10.

8.8.2 OPERATING SEQUENCE

To reset a latched supervision fault on a local ancillary relay, from the base display press:



to select ancillary relays

then press numeric key "1", "2" or "3" followed by the ENTER key to select the desired ancillary relay. Then press:



to reset the fault.

If the fault is still physically present on the relay wiring then the relay status will remain in fault.

8.9 ANCILLARY RELAY TEST

8.9.1 FUNCTION

To briefly turn on a local ancillary relay output for five seconds.

If the relay is isolated the test command will not energise the relay.

If the relay is already energised before the test starts then the test command will have no effect on the relay and will not de-energise it.

For network systems, to test an ancillary relay on a remote panel use a zone operate test command. Refer to Section 11.10.

8.9.2 OPERATING SEQUENCE

To test a local ancillary relay, from the base display press:



to select ancillary relays, then press



The relay will be energised for five seconds or until "ACK" is pressed again.

8.9.3 NOTES

Depending on programming, a test command may not be allowed on particular relays. In which case, the message "This relay may not be tested" will appear when an attempt is made to test it.

8.10 OPEN COLLECTOR STATUS RECALL OR TEST



8.10.1 FUNCTION



To view the state of a local open collector output. A test command may be used to turn on an open collector output for five seconds if not already on.

For network systems, to recall or test an open collector output on a remote panel use a zone recall command or a zone operate test command. Refer to Section 11.10.

8.10.2 OPERATING SEQUENCE - STATUS RECALL

To recall a local open collector output, from the base display press:

  to select open collector outputs, then press

   to recall open collector output nn status.

The display will show the open collector number on the top line and on the bottom line either activated or deactivated according to whether the output is currently on or off.

The  and 

keys may be used to step through the open collector outputs. Press the "CLEAR ESC" key to return to the base display.

8.10.3 OPERATING SEQUENCE - OPEN COLLECTOR TEST

From an open collector status recall selected as described above, press:

  to turn the open collector output on for five seconds or " CLEAR ESC" to abort.

If the open collector output is already on it will not be affected by the test.

If an open collector output is controlled by the default logic of zone alarm, then the output can be turned off, if it is on, by isolating the corresponding zone.

8.11 WARNING SYSTEM STATUS RECALL

The status of the Warning System can be shown on the LCD. This shows whether the Warning System is activated, isolated or in fault.

OPERATING SEQUENCE

From the base display press



In F3200, the Warning System has a unique zone number which is 198. Other types of panels may not associate a zone number with the Warning System. Zone numbering is more significant on networked systems and the full list of zone numbers used in F3200 is shown in Section 11.9.

The Warning System status recall includes the following:

- activated - if the Warning System is activated
- deactivated - if the Warning System is not activated
- fault - if there is a supervision fault on any of the Warning System outputs
- isol - if the Warning System is isolated
- deisol - if the Warning System is de-isolated
- SilAlms - For New Zealand operation, this will be shown if the Silence Alarms Keyswitch is operated
- NetSil - For a networked system this is shown if the local Warning System is inhibited (Silenced) by a Warning System isolate on another panel.

From the Warning System status recall display the



key can be used to operate the Warning System for 5 seconds,



the key can be used to isolate or de-isolate the Warning System.



The



keys can be used to show the next or previous zones. Zone 199 is the External Bell and zone 197 is Plant.

8.12 EXTERNAL BELL STATUS RECALL

The status of the External Bell can be shown on the LCD. This shows whether the External Bell is activated, isolated or in fault.

OPERATING SEQUENCE

From the base display press



In F3200, the External Bell has a unique zone number which is 199. Other types of panels may not associate a zone number with the External Bell. Zone numbering is more significant on networked systems and the full list of zone numbers used in F3200 is shown in Section 11.9.

The External Bell status recall includes the following:



- activated - if the External Bell is activated
- deactivated - if the External Bell is not activated
- fault - if there is a supervision fault on any of the External Bell outputs
- isol - if the External Bell is isolated
- deisol - if the External Bell is de-isolated
- NetSil - For a networked system this is shown if the local External Bell is inhibited (Silenced) by an External Bell isolate on another panel.

From the External Bell status recall, the



key can be used to operate the External Bell for 5 seconds,

the  key can be used to isolate or de-isolate the External Bell.

The  and  keys can be used to show the next or previous zones. Zone 198 is the Warning System and zone 197 is Plant.

9 PLACING INTO OPERATION

9.1 GENERAL

This chapter describes the procedure to place an F3200 FIP into operation. It assumes that the mains and other field wiring has been connected, but that the battery has not. Note that all electronic modules were tested and adjusted in the factory and should need no further adjustment.

Before switching on power, inspect the cabinet and internals. Check that all equipment is securely mounted, and that all cables are connected at the appropriate points. The factory checklist is included.

The "MAINS ISOLATE SWITCH" is located at the top right hand side of the cabinet rear, to the left of the mains transformer, behind the inner display door. This controls the mains power to the FIP, charger and power supply, and should be left on once the FIP is operational.

NOTE: The Battery is not disconnected by the "MAINS ISOLATE SWITCH".

9.2 POWER-UP

To place the F3200 FIP into operation, perform the following steps:

- STEP 1** Ensure that the Mains Isolate Switch is OFF.
- STEP 2** Ensure that 240 VAC is connected to the panel from the mains distribution switchboard.
- STEP 3** Turn the Mains Isolate Switch ON.
- STEP 4** Check that the buzzer sounds and all LEDs on the Operator Display panel flash for 2 seconds (except Mains On).
- STEP 5** Check that the green "MAINS ON" LED indicator is on.
The Controller performs tests on its memory, electronics, and the LCD.
Refer to Section 6.6 for a list of faults that may occur.
- STEP 6** Check that the LCD has good visibility. The LCD displays the FIP pcb configuration before showing the Base Display.
- STEP 7** Install and connect the batteries.
Take care not to short the battery leads when connecting.
- STEP 8** De-isolate all normalised zones and perform a System Test. (This takes almost one minute and includes a fault and alarm test of each zone).
- STEP 9** Perform a Battery Test. If Battery Test fails check the battery connections, leave for 24 hours and retest.
- STEP 10** Perform a Test of the External Bell and Warning System.

A full commissioning test should be performed as per AS1670.1.

9.3 COMMISSIONING CHECKLIST

The following checklist should have been completed and supplied by the manufacturer. It should be placed with other System Configuration Information. Commissioning staff should check the installed FIP against it. (Note that all pcbs are electronically tested and adjusted before being fitted to the FIP).

1. CABINET & GENERAL

- A) Cabinet colour - Standard Cream Wrinkle (BFF 998 CW)
- Other: _____
- B) Cabinet undamaged (Paint OK)
- C) Door aligned correctly
- D) Window undamaged and fitted correctly
- E) MCP fitted and undamaged
- F) Cabinet Door locks firmly, operates microswitch
- G) Lock - 003 Type & key supplied
- H) Door seals fitted to top and sides
- I) Display Keypad and 4U door fitted & aligned correctly
- J) Cardframe fitted correctly ..(FP0781/3 only)
- K) Standoffs fitted to cabinet rear (none missing)
- L) Operator Manual and battery leads included
- M) VIGILANT label completed

2. PCBS & WIRING

- A) MAF/PSU Fitted securely on standoffs
- B) Controller/Display fitted securely
- C) 8ZM fitted securely, earth screw fitted
- D) FRC Looms fitted correctly
- E) MCP & door switch wires fitted to J6 of MAF/PSU, secured
- F) Earth wire fitted to display door
- G) All 3 modules earth to cabinet metal

COMMISSIONING CHECKLIST (CONTINUED)

3. POWER SUPPLY

- A) Mains Wired correctly, MOV, cap fitted
- B) "Mains Isolate Switch" and "NAE" label fitted
- C) Mains Earth wired to stud, good contact
- D) All 6 fuses fitted to MAF/PSU
- E) Mains Switch neon off/on for switch off/on
- F) MAF/PSU Mains On LED on, Fuse Blown LED off
- G) VRECT at DC IN tab 40-42Vdc
- H) Charger Voltage 27.3-27.4V warm, 27.5-27.6V cold

4. OPERATION

- A) LEDs bright through window, "MAINS ON" LED on
- B) Correct modules are configured and found on Init
- C) Buzzer louder with microswitch operated
- D) Controller LK7 in "Protect" position
- E) LCD contrast correct for front view
- F) De-isolate zones, system test pass on all zones
- G) FIP MCP Programmed to Zone 1; Other: OK
- H) "ALM" LED flashes & buzzer pulses for MCP operation
- I) Acknowledge silences buzzer, Zone Resets

SERIAL NUMBER

TEST PASSED

DATE:

SIGNATURE

10 SYSTEM TESTING & MAINTENANCE

10.1 SYSTEM TESTING & FAULT FINDING

The F3200 has various test and diagnostic facilities to check functionality of the system and assist fault finding.

Self Testing includes checking: Controller memory; real time clock; I/O bus communications; modules present; and LCD module operation.

Should the Controller discover a fault it will annunciate a System Fault and take appropriate action. For example, for a module failure such that the Controller can no longer clock data to/from it, the Controller will display "Shift Register Clocking Fault", turn on the System Fault LED, de-energise the Standby relay and stop processing AZC status.

Auto Test operates on a daily basis (holidays excluded) and includes Fault testing and Alarm testing (programmable) of all AZC's.

Operator controlled tests include AZC (zone) Fault and Alarm tests, battery test, and output tests (e.g. Test Relay).

The supervision facility on AZCs, ancillary outputs and relay wiring allows detection of field wiring faults.

Routine testing should include checking the operation of the FIP and various outputs.

The cause of any faults within the system can be found as per Section 4.4.

Should a fault occur within the FIP electronics or system wiring, the operator should call a service person to check functionality and establish which facilities do not operate.

Only a suitably trained technician should attempt to repair wiring or replace suspect modules.

Test points on the pcb modules allow checking of DC voltages and various signals.

Once it is established which particular module has a fault, the FIP should be de-powered (mains and battery) and the module replaced. (Refer to Chapter 10.2).

Faulty electronic modules should be returned to the factory for repair and testing. It is not recommended that service staff repair electronic failures on site.

All faults and alarms should be recorded in the system log book, with time and date of occurrence.

10.2 MODULE REMOVAL

10.2.1 GENERAL

Modules should only be unplugged and plugged in with both the Mains off and the battery disconnected. Faulty modules should be replaced by good ones at the earliest possible time. Should a spare module not be available at the time a module is diagnosed as faulty and removed, it is possible to reconnect the other modules and run the system with a module missing. The FIP must be told which of its modules are missing to assign the correct inputs/outputs to the modules which are present.

WARNING

Suitable **precautions** should be made to **check for fire** in any unprotected areas, and to manually operate ancillary equipment which would otherwise be automatically operated.

NOTE

When fitting modules ensure that the single screw which connects the module to the cardframe (FP0781) or the cabinet (FP0780) is fitted firmly, as it earths the module.

10.2.2 CONFIGURATION

On power up with a module removed, the Brigade Standby relay remains de-energised, the FIP does not process input/outputs and the System Fault LED turns on.

Pressing "RECALL" "7" (Recall others) will display the appropriate fault message.

From the base display (totals) press "SET" "5" to view both modules configured and present e.g. "relay = 1/0" implies that one 8RM is configured, but none are plugged in.

Press "ENTER" then cursor along to the module which has been removed.



Press  to toggle between P (present) and N (not present).

Press "ACK" to save the correct temporary configuration. The F3200 then checks the temporary configuration is correct and prompts the operator to press "ACK" to confirm the temporary configuration. Subsequently the Standby relay energises but the System Fault LED remains on.

WARNING

If the **FRCs** to the **Controller/Display** are unplugged they must be replugged in with care. The FRC from the **MAF** must be plugged into the correct connector (**J14 I/O Bus OUT**) on the Controller. The FRC from a **LED Display** must only be plugged into the top connector (**J13 LED Display**).

Swapping these may cause damage to the electronics.

10.3 SYSTEM MAINTENANCE

The Australian Standard AS1851 requires that the building owner/occupier (or a nominated representative) to maintain the Fire Protection Equipment and to carry out system tests on a regular basis. For an NDU in New Zealand mode, regular testing must be carried out to comply with NZS4512 parts 402 and 403.

It is the responsibility of the owner/occupier to ensure that maintenance is performed.

Personnel performing maintenance tests must receive sufficient training and instruction.

It is normal for the owner/occupier to contract maintenance to a bona fide Fire Alarm Company.

For an NDU (which does not have any alarm zones), all of the following tests should be performed except for the zone alarm and fault tests.

The following tests are recommended:

10.3.1 WEEKLY TESTING

Where it is required, the recommended procedure for weekly testing is:

- Step 1:** Check that the LCD is showing the 'System Normal' base display and that the Mains On LED is on.
- Step 2:** Advise the Brigade (as per the specified local agreement) that you are about to undertake a routine test of the fire system. Inform all building occupants that the fire alarm system will be tested.
- Step 3:** Perform a System Test.
- Step 4:** Select one zone and perform an Alarm Test.
- Verify that:
- (a) The External Bell operates,
 - (b) The Warning System operates,
 - (c) The Alarm Signal is received by the Brigade.
- Reset the alarm.
- Step 5:** Perform a Battery Test.
- Step 6:** Check that the LCD is showing the 'System Normal' base display and that the Mains On LED is on.
- Step 7:** Record the results of these tests in the Log Book.
- Step 8:** Inform the Brigade and all others concerned that the test is concluded.

10.3.2 MONTHLY TESTING - AUSTRALIA

In addition to the Weekly Testing described above, perform the following:

- STEP 1:** Initiate a System Test.
This tests that all common paths for alarm and fault information are working correctly, and that all inputs are capable of detecting alarm and fault signals.
- STEP 2:** Initiate a Zone Alarm Test on one or more zones. This checks that the brigade can be signalled, that the particular zone(s) tested operate correctly and that the common modules processing alarms operate correctly. Choose a different zone each month.
- STEP 3:** Initiate a Zone Fault test on one or more zones.
This checks that the brigade can be signalled (if wired), that the particular zone(s) tested operate correctly and that the common modules processing faults, including the turning on of individual fault LEDs and turning on the fault buzzer, operate correctly. Choose a different zone each month.
- STEP 4:** Check the Database for Validity.
Recall the Database CRC and last change date/time (refer Section 6.14), and compare these with the values recorded in the log book. If they are not the same then the database has been changed and may need to be validated and saved.
- STEP 5:** Check that there are no system faults.
This checks that all common paths for transmission of alarms and faults are operational.
- STEP 6:** Visually inspect the cabinet and panel to ensure it is clean, operable and intact. Inspect the dust seal, and ensure that it is undamaged.

NOTES:

1. If there are Sub-Indicator Panels, RZDU, Mimics, repeater Panels, etc; these also require testing and inspecting.
2. The daily Auto Test will perform a Fault Test on each zone. Unless programmed not to, it will also perform Alarm Test on each zone.

10.3.3 ANNUAL TESTING

Australian Standard AS1851.8 requires that all fire detection and alarm systems be thoroughly tested each year by a competent service/maintenance company.

The service/maintenance company should ensure that the performance of the procedure set out in AS1851.8 is witnessed by the owner of the F3200 System installation, or the owner's authorised agent.

10.4 PREVENTION OF FALSE ALARMS

Fire detection systems rely on sensors to identify atmospheric or environment changes brought about by the presence of fire. They employ various types of sensors to monitor specific conditions. These devices signal a warning when an abnormal condition exists, indicating either the presence of a fire or the immediate likelihood of an outbreak.

There are detectors to monitor heat, flame, water pressure or the presence of combustion products such as smoke or gases. However, some or all of these conditions may appear in different locations when there is no fire present. For example:

- (a) **HEAT SOURCES;** The sudden increase in local temperature when a furnace door is opened can trigger heat sensors.
- (b) **DRAUGHTS, DUST, STEAM, CHEMICALS;** Wind-induced surges of dust, release of steam or chemicals can cause smoke detectors to generate an alarm signal.
- (c) **ENVIRONMENT CHANGES;** Changes to wall partitions, Air-Duct position or air velocity can cause detectors to be forced into continuous alarm.
- (d) **CONSTRUCTION AND MAINTENANCE ACTIVITIES;** Portable welding units can activate flame detectors, while spray-painting 'drift' can trigger smoke detectors.

It is therefore highly recommended that the service company be notified of any proposed physical, environmental or occupancy changes.

11 NETWORK SYSTEMS

11.1 INTRODUCTION

This chapter describes the operation of networked systems and is not relevant to users of non-networked F3200 panels.

Multiple F3200 fire panels and NDUs (Network Display Units) along with other devices, may be connected together to form a network.

Some of the devices which may be part of the network include:

1. F3200 fire panels.
2. NDU - network display/printer unit.
3. PTM - Protocol Translation Module for interface to XL colour graphics or for event printing.
4. Network LED display unit (NLDU) for display of network zone states on LEDs.
5. Panel-link Modbus Bridge (PMB), which provides a Modbus output of network states for connection to colour graphics systems (e.g. Overview) or building management system (BMS) that support the Modbus protocol.

Except where otherwise stated, the commands and information in Chapters 1 to 10 of this manual apply to networked F3200s and to NDUs.

The operation of an NDU is almost identical to the operation of a networked F3200 and is described in Section 11.2.

Networking allows F3200 fire panels to share:

- (i) Alarm information for display and control of alarms on the LCD. Alarms on one FIP can be displayed at other FIPs and Colour Graphics displays. Alarms can be acknowledged, reset and isolated from the FIPs and Colour Graphics displays.
- (ii) Output logic status, allowing status and controls generated by the Output Logic at one FIP to be used by the Output Logic at another FIP, e.g. for extended AS1668 Fan Controls.
- (iii) MAF Status, so that one FIP can be a common brigade interface point for a number of FIPs elsewhere on site.
- (iv) Event Information for status monitoring and network event printing. An F3200 FIP may be programmed to perform system wide event printing and event history.
- (v) Control for activating, isolating and silencing the External Bell and Warning System on remote FIPs as a result of alarms or operator controls on the local FIP.
- (vi) For an NDU in New Zealand mode, the Trial Evac and Silence Alarms keyswitches can affect all panels on the network and allow the system to be controlled from a single point.

INTRODUCTION (CONTINUED)

Network Zone Functions

1. Recall the status of a specific zone on a remote FIP.
2. Search for zones of a specific condition on remote FIPs.
3. Send reset, isolate, de-isolate, alarm test, fault test, abort test, and operate test commands on a single zone or range of zones to a remote FIP.

Network System Functions

System functions which may be sent to or from network panels are:

1. System Test
2. System Fault Reset
3. Battery Test
4. Set Time/Date
5. External Bell / Warning System Isolate / De-Isolate / Test
6. Recall Database CRC
7. For an NDU in New Zealand mode Trial Evacuation and Silence Alarms
8. Silence sounders on all network panels

Network Event Logging

Networked FIPs can be programmed to transmit their events onto the network for use by network printers, colour graphic systems, etc.

An F3200 FIP or NDU may be used as a system-wide history/event printer and may be programmed to print events for selected FIPs on the network, and to log events for those selected FIPs into the event history.

LCD Totals, LEDs and Outputs

Depending on the programming of the FIP the state of these may include, or be affected by, data received from other devices on the network.

11.2 NDU - NETWORK DISPLAY UNIT

An NDU can be thought of as an F3200 FIP without any alarm zone modules or relay modules. An NDU also has an option of MAF board present/not present.

An NDU without a MAF board is physically quite small, convenient to use, and is powered from an external source. An NDU with a MAF board may perform brigade signalling functions and also has ancillary and bell relays.

Even though an NDU does not have any 8 zone or 8 relay modules, it does have 16 alarm zones. The local MCP (or connected RDU MCP), if any, may be mapped to any one of these 16 zones. Each of the 16 zones may be isolated, de-isolated, or reset, but cannot be tested. Each zone can be programmed as latching/non-latching, MAF/non-MAF, etc. Even though an NDU zone which does not have an MCP mapped cannot go into alarm, it may be useful as an object which can be isolated or de-isolated (as this state can be sent to other panels on the network).

Otherwise an NDU will perform all the functions of an F3200 panel, including sending/receiving network zone commands, network event printing, and FF alarm display.

An NDU may be programmed with output logic, the same as F3200, and may send and receive network logic variables on the network.

An NDU without a MAF board may still perform the functions of External Bell, Warning System, and/or or Ancillary Relay Isolate / De-Isolate / Test, and the output logic tokens associated with these may be used so that these conditions can be accessed from other panels.

The keypad on an NDU without a MAF board is physically accessible all the time, but when the cabinet is locked the NDU disables the keypad even though the keypad is physically accessible. It is possible to program selected keys to be operational when the NDU cabinet is locked.

Section 4.1.1 describes the interpretation of the front panel LEDs on an NDU.

If an NDU is programmed to use the totals sent by another device on the network, then the NDU will turn its buzzer on if a new MAF fault, Standby condition or new System fault occurs on the remote device.

NDU in New Zealand Mode

An NDU can be programmed to operate in either New Zealand mode or Australian mode. New Zealand mode operation is not available on an F3200 panel.

11.3 LCD TOTALS, LEDs, OUTPUTS & BUZZER OPERATION

For a networked F3200 or NDU, the interpretation of the front panel LEDs is described in Section 4.1.1.

However, the operation of the Off-Normal totals, buzzer, MAF relays, and Ancillary relays may be affected by states coming from other panels on the network, depending on programming.

11.3.1 LCD TOTALS

The totals shown on the LCD display may include totals received from other devices on the network.

A recall net SID status function is provided to show the individual totals local to this panel and the totals currently being received from any other device on the network (from the base display press RECALL RECALL 3 - refer to Section 11.6.2). Refer also to Section 4.2.2 (Base Display).

11.3.2 BUZZER OPERATION

The buzzer turns on:

Steady: For a local fault or system fault, or a MAF fault, standby condition or System fault received from another network device for which this panel has been programmed to include the totals of.

Pulsing: For a new alarm being put into the FF list or a new MAF alarm on the local panel.

Rapid Pulsing: For a local test failure, e.g. system test.

The buzzer is turned off:

1. Whenever a key is pressed on the keypad.
2. When there are no more unisolated alarms or faults.
3. When a system fault reset command is received from another device on the network.
4. When the buzzer is turned off at another device on the network (depends on programming).
5. When a "silence all network sounders" command is received from another panel on the network.

11.3.3 MAF RELAYS

The MAF states received from another device on the network will be used by this panel to drive its MAF outputs (if any) if this panel has been programmed to use the MAF states of the other device.

MAF Alarm Relay

Energised for a local MAF alarm or for a MAF alarm state received from another device. (For an NDU in New Zealand mode, the MAF alarm relay is normally energised and de-energises for alarm).

MAF Fault Relay

Energised for a local MAF fault or System fault or for a MAF fault, standby condition or system fault state received from another device.

MAF Isolate Relay

Energised for a local MAF isolate condition or for a MAF isolate state received from another device.

MAF Standby Relay

De-energised for a local "Standby Fault". It does not de-energise for a Standby condition received from another device.

Ancillary Relays

Unless controlled by output logic, this relay is not affected by states from other network devices and operates for a local alarm on a zone mapped to it.

Ancillary 2 Relay

For both networked and non-networked panels, this relay is controlled by an output logic equation, for which the default operation is that the relay operates when the External Bell is activated.

Ancillary 3 Relay

For both networked and non-networked panels, this relay is controlled by an output logic equation for which the default operation is that the relay operates when the Warning System is activated.

External Bell

The activation of the External Bell is controlled by an output logic equation, for which the default operation is that the External Bell is activated when:

1. Any local zone mapped to the External Bell is in alarm.
2. The External Bell is tested.

BUZZER OPERATION (CONTINUED)Warning System

The activation of the Warning System is controlled by an output logic equation, for which the default operation is that the Warning System is activated when:

1. Any local zone mapped to the Warning System is in alarm.
2. The Warning System is tested.
3. There is an alarm on a zone in In-Situ test mode that is mapped to the Warning System.

For an NDU in New Zealand mode the Warning System is usually programmed to operate for Trial Evacuation.

11.4 EXTERNAL BELL/WARNING SYSTEM ISOLATE/SILENCE

11.4.1 WARNING SYSTEM

The Warning System can be isolated locally or it can be silenced by a Warning System Silence state received from other devices on the network.

For New Zealand mode, the Warning System can also be silenced by activation of a Silence Alarms keyswitch.

Depending on programming, when the Warning System is isolated locally, this panel may send a Warning System Silence state onto the network which may cause the Warning System to be silenced (inhibited) at other panels on the network, depending on their programming.

Hence when the  key is used to Isolate the Warning System at one panel on the network, it can result in the Warning System being silenced at other panels on the network.

The Warning System Isolate LED indicates whether the Warning System is isolated or silenced as follows, in order of priority.

Warning System Isolate LED

Flash at 2Hz	:	A Silence Alarms Keyswitch is activated (NZ only)
Slow flash	:	Warning System inhibited by network silence
On steady	:	Warning System locally isolated
Off	:	None of the above i.e. the Warning System outputs will operate for alarm

For an NDU without its own Warning System output, the information shown on the Warning System Isolate LED is still useful because it shows the network Warning System silence status.

11.4.2 EXTERNAL BELL

The External Bell can be isolated locally or it can be silenced by a External Bell Silence state received from other devices on the network.

Depending on programming, when the External Bell is isolated locally, this panel may send a External Bell Silence state onto the network which may cause External Bell to be silenced (inhibited) at other panels on the network, depending on their programming.

Hence when the  key is used to Isolate the External Bell at one panel on the network, it can result in the External Bell being silenced at other panels on the network.

The External Bell Isolate LED indicates whether the External Bell is isolated or silenced as follows, in order of priority.

External Bell Isolate LED

Slow flash	:	External Bell inhibited by network silence
On steady	:	External Bell locally isolated
Off	:	None of the above i.e. the External Bell outputs will operate for alarm

For an NDU without its own External Bell output, the information shown on the External Bell Isolate LED is still useful because it shows the network External Bell silence status.

11.5 NETWORK FIP & ZONE NUMBERING

When F3200 FIPs are networked together there must be a way to identify each FIP and the zones on that FIP.

In this manual, reference is made to "local" and "remote" panels. A local panel is the panel at which the operator is at. Remote panels are all other panels on the network. This applies even if a number of networked panels are co-located.

When a networked FIP is configured, it is programmed with a unique number between 1 and 254. This is its System Identification Number, or SID. The SID is used to:

- (a) Identify a specific FIP.
- (b) Identify a zone on a specific FIP, by combining the SID and Zone number as detailed below.

For a networked FIP, zone numbers and zone ranges fall into 3 formats:

- (i) Zone number(s) less than 1000 are local zones, ie. specific to the panel at which the number is being entered or displayed, eg. Z57, Z135.189.
- (ii) Zone number(s) greater than, or equal to, 1000 are network zones, eg. Z32105 or Z17001.17095. The SID of the FIP that has the zone is the network zone number divided by 1000. The actual zone number on that FIP is the remainder after dividing by 1000.
Eg. Z1057 is Zone 57 on FIP number 1.
Z35218 is Zone 218 on FIP number 35.
Note that all zeros must be entered, eg. for Zone 1 on Panel 2, the entry must be 2001, ie. the intermediary 0s are necessary.
- (iii) Zone numbers less than 1000 preceded by the SID of the FIP that has the zone(s) and separated by a : or double points "...". ,eg.
(a) Z57:1 - Zone 1 on Panel 57.
(b) Z2:135.208 - Zones 135 to 208 on Panel 2.
(c) Z61..72 - Zone 72 on Panel 61.
(d) Z85..24.154 - Zones 24 to 154 on Panel 85.

A colon is entered using the SYSTEM key. Double points are entered by pressing the AND. key twice.

For F3200, zone numbers can be entered in any of the above formats. However, any zone range that extends across more than one FIP, eg. Z35097.36002 is illegal.

F3200 always displays network zones in format (ii), and event printing uses format (iii).

If a zone number or range is entered in formats (i) or (ii), and the SID is that of the local FIP, then the zone number(s) may be converted back to format (i) for local processing.

When alarm events are sent from one FIP to another on the network, the zone number is sent as network zone format (ii) for display on the LCD.

11.6 SYSTEM FAULT RECALL/NET PANEL STATUS RECALL

As described in Section 6.6.2, a RECALL SYSTEM command can be used to recall all system faults.

As well as the faults listed in Section 6.6.3, a system fault recall (or network device status recall) will display up to 5 "pages" of information for each device on the network, beginning with the local panel. The "pages" are numbered 0 to 4, and the information shown is described in Section 11.6.3.

11.6.1 NETWORK SYSTEM FAULT RECALL

This is the same as described in Section 6.6.2. From the base display, press:



Use NEXT and PREV keys to step through the faults. The system faults shown are listed in Section 6.6.3 plus the additional faults listed in Section 11.6.3 below.

11.6.2 NETWORK PANEL STATUS RECALL

The five pages of panel status listed in Section 11.6.3 may be recalled by a panel status recall command. From the base display, press:



Then press 1, 2 or 3 to select the desired option as follows:

1. All net SIDs.
2. Select SID.
3. All off normal SIDs.

Option 1: All net SIDs, will step through all panels on the network that are in the SID list of this panel, starting with the local panel.

Option 2: Select SID, will prompt for the entry of a SID number and will start the recall from the selected SID, and is otherwise the same as Option 1.

Option 3: All off normal SIDs, will display only those SIDs that have off normal conditions or have non-zero totals.

11.6.3 NETWORK PANEL STATUS

The network panel status is shown as a sequence of pages containing fault and status information. For a non-networked panel this information appears with the heading "System Status Summary".

Network Panel Status Page 0

- ScanF - The Local Panel is not receiving any data from the Remote Panel.
- LnkIA - The Local Panel is not receiving Channel A test data from the Remote Panel.
- LnkIB - The Local Panel is not receiving Channel B test data from the Remote Panel.
- SysFlt - The Remote Panel has a system fault.
- NetFlt - The Remote Panel has a network fault.
- Stdbby - The Remote Panel has generated a standby condition.

Network Panel Status Page 1

- Abnml - The Remote Panel has an Abnormal status present.
- BellI - The Remote Panel's bells are isolated. (See note 1)
- TEvac - The Remote Panel is asserting Trial Evacuation.
- SilAlm - The Remote Panel is asserting Silence Alarms (Silence Bells). (See note 1).
- BrigT - The Remote Panel is asserting Brigade Test.
- SysFRcl - The Remote Panel has information that should be recalled on its own LCD display using the System Fault recall command.

Network Panel Status Page 2

- MafAlm - The panel has a MAF alarm condition.
- MafFlt - The panel has a MAF fault condition.
- MafIso - The panel has a MAF isolation condition.
- NMAIm - The panel has a non-MAF alarm condition.
- NMFlt - The panel has a non-MAF fault condition.
- NMIso - The panel has a non-MAF isolate condition.

Network Panel Status Page 3

- CmnPtl - Common point isolate.
- SysTst - A system/auto-test is in progress.
- TstFil - Test fail indication. A zone/system/auto-test has failed and the test fail buzzer is currently active.
- PSUFlt - Indicates a Power Supply or battery fault e.g. mains fail, charger low, battery low, battery connection or battery capacity.
- LatBVLO - For New Zealand mode, this indicates a latched Battery Very Low Alarm.
- BSR - For New Zealand mode, indicates Building Services Restore keyswitch activated.

Network Panel Status Page 4

- WOpr - The Warning System at the panel is operated.
- WIsO - The Warning System at the panel is isolated.
- WSil - The panel is sending Warning System silence.
- WAlm - There is a non-isolated zone mapped to the Warning System in alarm at the panel.
- BOpr - The External Bell at the panel is operated.
- BIsO - The External Bell at the panel is isolated.
- BSil - The panel is sending External Bell silence.
- BAlm - There is a non-isolated zone mapped to the External Bell in alarm at the panel.

Network Panel Status Page 5

Page 5 shows the 4 totals being transmitted onto the network by the panel - alarm, fault, isolate, other. For the local panel the page 5 totals only show the off normal conditions being generated by this panel - these may not be the same as the values shown on the base display because the base display may show combined totals from multiple panels.

NOTE 1: The BellI and SilAlm status in Page 1 are meaningful only for a panel running AS1603.4 type software. When a network system has a mixture of older AS1603.4 panels and new AS4428 type panels, the older panels don't have a Warning System or External Bell. However, their Bells/Bells Isolate state normally correspond to the External Bell on the AS4428 panels and will interact with the AS4428 panels as if it were an External Bell. Hence when the BellI status is shown in Page 1, the BIsO status will also appear in Page 4 as they represent the same state.

The mapping of Bell states on an older panel to External Bell on a newer panel is programmable, and for New Zealand operation the Bell states on an older panel actually map to the Warning System on a newer panel.

11.7 NETWORK COMMAND RESPONSES & EXCEPTION MESSAGES

Whenever a network command or status recall is initiated with the keypad, the display will show a variety of information or response messages listed in Section 11.7.1.

When a network command is received by a remote device, the device may take from several seconds to several minutes to carry out the command (e.g. System Test). When the command or test is completed the device may send an exception message to indicate the result of the test. Exception messages are listed in Section 11.7.2.

11.7.1 NETWORK COMMAND RESPONSES

1. "Sending Command"
The command is now being sent across the network.
2. "Command Accepted"
The command arrived successfully at the remote device and is now being processed.
3. "Command NOT Accepted"
The command arrived successfully at the remote device, but is not able to be executed for one of the following reasons:
 - (i) Invalid zone number.
 - (ii) Invalid command type - e.g. alarm test on relay zone.
 - (iii) Command not supported.
 - (iv) Panel busy - e.g. system test already in progress.
4. "Command Timeout. No response"
The command did not arrive successfully at the remote device and was not acknowledged by that device.
5. "Command NOT accepted. Try Again"
The command arrived successfully at the remote device but was not able to be executed at the present time but may be able to be at some future time. This could occur if the panel was in program mode.
6. "Data Retrieve Timeout. Retrying"
This indicates that the remote panel is not responding with some status information when requested - such as for a zone status recall. The local panel will automatically retry every few seconds (programmable time) to get the information.
7. "Net Command Tx Disabled for SID"
The local panel has not been programmed to allow the sending of commands to the specified SID. The local panel needs to be programmed with the list of SID's that it is allowed to send commands to.
8. "Illegal or Invalid Command"
This could occur for the reasons listed in item 3 above, such as invalid zone number.

NETWORK COMMAND RESPONSES (CONTINUED)

9. "Network Panel Not Processing"
The remote panel is in program mode and cannot accept commands.
10. "Retrieve Timeout. No Response"
The Remote Panel did not acknowledge a request for information.
11. "Unable to Access Network"
This indicates a hardware fault such as a break or short circuit on the network cabling.
12. "Local Net Transmit Queue Full"
All commands initiated are entered into a queue until the network driver is able to send them. It is only in extreme or fault situations that the queue would become full.

In a fault situation it may be that the queue remains full until the fault clears.
The command should be retried.

11.7.2 EXCEPTION MESSAGES

When an exception message is received from a remote device, it is immediately shown on the display, temporarily interrupting whatever is being shown on the display at the time. The display shows the number of the SID which sent the exception message. The pressing of any key will clear the exception message and restore the display.

Exception messages which may be shown are:

"Not All Zones De-Isolated"

The zone range de-isolation command processed did not de-isolate one or more zones because they were in alarm or fault.

"Zxxxxx Test Passed"

"Zxxxxx Test Failed"

"Zxxxxx Test Aborted"

"Zxxxxx Test Time Out"

The previous Zone test command issued to zone xxxxx had the indicated result.

"System Test Passed"

"System Test Failed"

"System Test Aborted"

The previous System test command had the indicated result.

"Battery Test Passed"

"Battery Test Failed"

"Battery Test Aborted"

The previous Battery test command had the indicated result.

11.8 NETWORK SYSTEM COMMANDS

11.8.1 NETWORK SYSTEM TEST

To initiate a system test on a remote device, from the base display press:



Then enter the SID number 1 to 254 using the numeric keys 0 to 9, followed by the ENTER key. The top line of the display then shows the name of the selected SID and the bottom line gives a list of options 1 to 3 as follows:

1:System 2:Zone 3:Battery

Select option 1 (system), then press the ACK key to initiate the test.

The display will indicate if the command was accepted by the remote device. The remote device may send an exception message to indicate if the test passed or failed.

11.8.2 NETWORK SYSTEM BATTERY TEST

To initiate a battery test on a remote device, from the base display press:



Then enter the SID number 1 to 254 using the numeric keys 0 to 9, followed by the ENTER key.

The top line of the display then shows the name of the selected SID and the bottom line gives a list of options 1 to 3 as follows:

1:System 2:Zone 3:Battery

Select Option 3 to initiate a battery test at the remote device.

The display will indicate if the command was accepted by the remote device. The remote device may send an exception message to indicate if the test passed or failed.

11.8.3 NETWORK SYSTEM FAULTS RESET

To send a system fault reset command to a remote device, from the base display press:

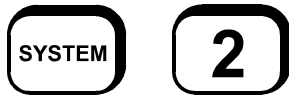

Then enter the SID number 1 to 254 using the numeric keys 0 to 9, followed by the ENTER key.

The top line of the display then shows the name of the selected SID and the bottom line gives options 1 to 4 as follows:

1: System Test 2: Faults Reset 3: Warning System 4: External Bell.

Select option 2: Faults Reset, i.e. press numeric key 2.

11.8.4 NETWORK RECALL DATABASE CRCs

It is possible to recall the database CRC from a remote F3200 or NDU. This information can be used as part of an AS1851.8 testing schedule.

From the base display, press:



then press:

1. For all panels (SIDs).
2. Local panel.
3. A selected panel.

For Option 1, the LCD will first display the database CRC for the local panel. The NEXT and PREV keys may then be used to step to the next or previous panel in the system. Some devices on the network may not support the remote database CRC recall function, in which case an error message will be displayed and an option given to retry (ACK key) or to step to the next panel (NEXT key).

To exit from the recall at any time, press the CLEAR key.

NOTE: Any changes made to the database will change the numbers displayed in this recall. Thus, if the database is changed, the new numbers should be recorded in the log book and the service company advised.

11.8.5 NETWORK EXTERNAL BELL ISOLATE/DE-ISOLATE/RECALL/TEST

To isolate, de-isolate, test or recall the status of the External Bell at a remote device, from the base display press:

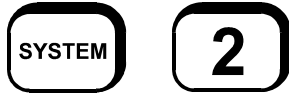

Then enter the SID number 1 to 254 using the numeric keys 0 to 9 followed by the ENTER key.

The top line of the display then shows the name of the selected SID and the bottom line gives options 1 to 4 as follows:

1: System Test 2: Faults Reset 3: Warning System 4: External Bell

Select Option 4: External Bell

The display will then show the current External Bell isolate state of the selected SID and a list of options as follows:

1. Test .
2. Isolate.
3. De-Isolate.

Press numeric key 1, 2 or 3 to select the desired option, then press the ACK key when prompted to initiate the command.

An External Bell test will result in the External Bell output at the remote device turning on for a few seconds and then automatically turning off (if not previously on).

11.8.6 NETWORK WARNING SYSTEM ISOLATE/DE-ISOLATE/RECALL/TEST

To isolate, de-isolate, test or recall the status of the Warning System at a remote device, from the base display press:



Then enter the SID number 1 to 254 using the numeric keys 0 to 9 followed by the ENTER key.

The top line of the display then shows the name of the selected SID and the bottom line gives options 1 to 3 as follows:

1: System Test 2: Faults Reset 3: Warning System 4: External Bell

Select Option 3: Warning System

The display will then show the current Warning System isolate state of the selected SID and a list of options as follows:

1. Test.
2. Isolate.
3. De-Isolate.

Press numeric key 1, 2 or 3 to select the desired option, then press the ACK key when prompted to initiate the command.

A Warning System test will result in the Warning System output at the remote device turning on for a few seconds and then automatically turning off (if not previously on).

11.8.7 NETWORK SET TIME/DATE

Section 6.9 describes how to set the local time/date. If programmed to, setting the local time/date will also cause the new time/date to be sent on to the network to set the time/date at other devices.

If programmed to, this panel may also set its local time/date whenever it receives time/date from the network.

If programmed to, a device will automatically transmit time/date onto the network every 12 hours at 11:30am and 11:30pm and also when the time is changed due to a daylight saving time change.

11.8.8 SILENCE ALL NETWORK SOUNDERS

If enabled with programming, there is a command that can be used to silence the sounders of all panels on the network (depending on their programming).

From the Base display press:



The message "Sending network sounder silence" will be shown.

11.9 REMOTE RELAY & OPEN COLLECTOR OPERATION & ZONE MAPPING

An F3200 panel maps its inputs and outputs to zones as follows so that they can be accessed across the network using the zone number.

Zones 1-64	- Alarm zones 1-64
Zones 65-128	- Module relays 1-64
Zones 129-192	- Open collectors 1-64
Zone 193	- Invalid
Zone 194	- Ancillary relay 1
Zone 195	- Ancillary relay 2 (External Bell*)
Zone 196	- Ancillary relay 3 (Warning System*)
Zone 197	- Plant isolate
Zone 198	- Warning System
Zone 199	- External Bell

For example, to recall the status of module relay 3, a recall of zone 67 would be done.

When a recall command is done to search for zones in a particular condition, the recall includes a search of all the above zones except for open collectors which are never included in zone searches.

Note that local module relays, open collectors and ancillary relays are also accessible by pressing the RELAY key from the base display. This requires the entry of an actual relay number rather than a zone number.

Module relays and ancillary relays on a remote F3200 panel (or NDU) may be recalled, isolated, de-isolated, reset or tested using a zone recall, isolate, de-isolate, reset or test command (as described in Section 11.10) with the appropriate zone number determined from the mapping above.

To test a remote relay or open collector, use a zone operate test command, (option 3 from the test menu), as described in Section 11.10.6, using a zone number determined from the mapping above.

* By default zone 195, Ancillary 2, is the External Bell output, and Zone 196, Ancillary 3, is the Warning System output. This might not apply if the panel's programming is changed from the default.

11.10 NETWORK ZONE RECALLS & COMMANDS

11.10.1 ZONE RECALLS

Section 4.2.2 describes how to recall alarms, faults, isolates, and "others". For a network panel this will search all programmed devices on the network as well as the local panel.

Network zones may also be recalled and searched as described in the following sections.

11.10.2 LOCAL OR NETWORK ZONE STATUS RECALL

To recall a specific zone's status, press:



where nnnnn is a network zone number.

The first line of the LCD displays the zone number and any zone name programmed for that zone.

Note that there may be a delay between requesting a network zone status and display of the true status, due to network delays. In this case, the panel will display default text, ie. just the network zone number, until the data is received. The display will update with the zone name and status when it is received.

The second line displays the zone alarm type text for that zone, followed by its status.

The status consists of any of the following:

Alarm	- the zone is in alarm.
Operate	- the ACZ is operated.
Fault	- the zone is in fault.
Isolate	- the zone is isolated.
Test	- the zone is currently being tested.
ARst	- the zone is currently being auto reset tested.
Normal	- the zone is normal.

To view other zones in the same condition press the NEXT or PREV keys.

11.10.3 NETWORK ZONE SEARCHES

The zone search functions allow an operator to search the local FIP and other network FIPs for zones meeting specified status criteria, e.g. in alarm.

From the base display press:



Then press numeric key 1, 2, or 3 to search:

- | | |
|-------------------|--|
| 1: All SIDs. | The local panel plus all programmed remote devices. |
| 2: Local SID only | Local panel only. |
| 3: Select SID | Prompts for the entry of a SID number - enter the SID number with the numeric keypad followed by ENTER, to start the search at a particular device on the network. |

A further set of options 1 to 6 will be given as follows:

- 1: All off normal
- 2: Alarms
- 3: Faults
- 4: Testing
- 5: Isolated
- 6: Status

Press numeric keys 1 to 6 to select the desired option.

When an option has been selected, the FIP searches for the first zone that meets the specified criteria.

If there are no local zones that meet the criteria, the FIP then polls the other FIPs on the network to determine whether they have any zones that meet the criteria.

Once a zone is found that meets the criteria specified, the LCD display reverts to a zone status display for that zone. When the NEXT or PREV key is pressed, the search continues for the next or previous zone, respectively, that meets the original search criteria.

While the panel is determining the next or previous zone that meets the criteria the LCD displays "Searching".

If no zones matching the criteria are found, the LCD briefly displays a message saying so, and reverts to the base display.

Note that due to network and remote panel delays a zone search command may take some time to complete, especially for larger systems with no zones that match the search criteria.

11.10.4 NETWORK ZONE ISOLATE OR DE-ISOLATE

To isolate or de-isolate a zone or range of zones on a network panel. If the network zone(s) entered are on the local panel, then the command is implemented locally as if the command had not used the network numbering format.

11.10.4.1 Operator Sequence - Single Network Zone

To isolate or de-isolate network zone n n n n n. From the base display, press:



The LCD will display the selected network zone, plus the options to isolate or de-isolate it. The status of the zone is retrieved from across the network. There may be a small delay before this is displayed. The display will also show options 1:Isolate and 2:De-isolate. Select the desired option.

The LCD will display the network zone with a message saying "Sending Command". After a brief period the message should change to "Command Accepted". Refer to Section 11.7 for more detail on these and other possible LCD display messages.

11.10.4.2 Operator Sequence - Network Zone Range

To isolate a range of network zones, from the base display press:

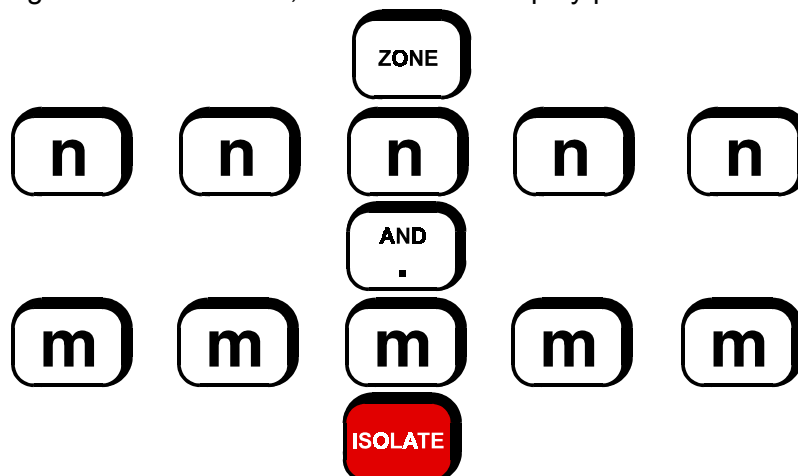

The LCD will display the selected range of zones, i.e. zone n n n n n to zone m m m m m inclusive, plus the options to isolate or de-isolate the range.

Then press:

1 To isolate the range of zones, or

2 To de-isolate the range of zones.

A prompt is then given to select the type of zones to isolate/de-isolate. Press

1. to isolate/de-isolate only alarm zones.
2. to isolate/de-isolate only ancillary zones.
3. to isolate/de-isolate all zones.

OPERATING SEQUENCE - NETWORK ZONE RANGE (CONTINUED)

The LCD will display the network zone range with a message saying "Sending Command". After a brief period, the message should change to "Network Command Accepted". Refer to Section 11.7 for more details on these and other possible LCD display messages.

Note that if the remote panel is unable to de-isolate all of the zones due to some having an alarm or fault status, then an exception message will be received indicating this. Refer to Section 11.7 for Exception Messages.

11.10.4.3 Notes

- (i) The effect of the isolate/de-isolate command is dependent upon the remote FIP type, eg. which zones will be isolated/de-isolated, how a zone is affected by isolation/de-isolation, and so forth.
- (ii) Refer to Section 7.2.4 for information on how an F3200 panel processes a zone isolate/de-isolate command.

11.10.5 NETWORK ZONE RESET

11.10.5.1 Function

A Network Zone Reset command sends a Reset Zone(s) command to the remote FIP that has the zone(s). If the network zone(s) are on the local FIP, the command is implemented as a local zone(s) reset.

11.10.5.2 Operating Sequence - Single Network Zone

From the base display press:



to reset network zone number n n n n n. Press ACK to initiate the reset command.

The LCD will display the network zone with a message saying "Sending Command". After a brief period the message should change to "Command Accepted". Refer to Section 11.7 for more details on these and other possible LCD display messages.

If an exception occurs at the remote FIP, then an exception display may be received indicating the type of exception. Refer to Section 11.7 for Exception Messages.

11.10.5.3 Operating Sequence - Network Zone Range

From the base display press:

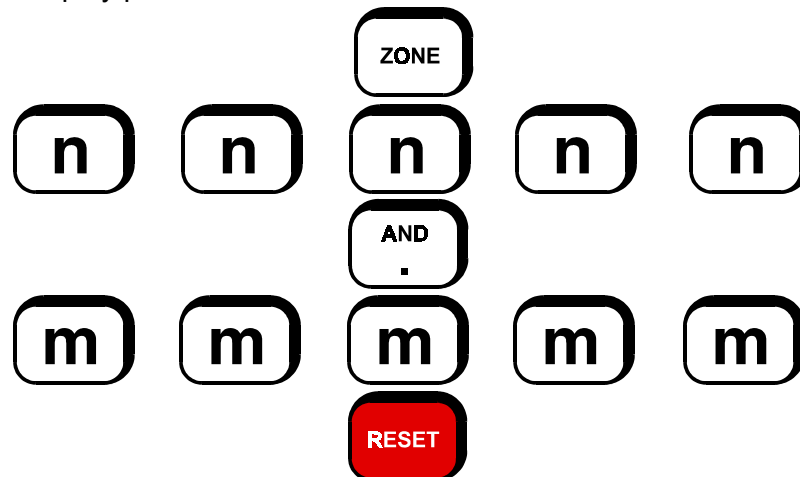

to reset network zone numbers n n n n n to m m m m m. Press ACK to initiate the reset command.

The LCD will display the network zones with a message saying "Sending Command". After a brief period the message should change to "Command Accepted". Refer to Section 11.7 for more details on these and other possible LCD display messages.

If an exception occurs at the remote FIP, then an exception display may be received indicating the type of exception.

IMPORTANT The range of zones entered must be limited to zones on a single networked FIP, i.e. the range cannot encompass zones on more than one FIP. For an F3200 panel the zones must be all of the same type, i.e. all alarm zones or all relay zones, etc.

11.10.6 NETWORK ZONE TESTS

11.10.6.1 Function

To initiate a test of a zone at a remote FIP. The zone tests can:

- Test the circuit inputs of the selected alarm zone;
- Send test signals to the Brigade;
- Operate test an ancillary control zone, relay or open collector output.
- In-situ test an alarm zone,

as if the test was initiated by an operator at the remote FIP. Tests at the remote FIP can also be aborted.

If the network zone to be tested is on the local FIP, the test menus continue as if a local zone number had been entered. Refer to Section 7.1 for details on testing of local alarm zones, and Sections 8.5, 8.9 and 8.10 for testing of relays and open collectors.

11.10.6.2 Testing a Single Zone

SUGGESTION: To prevent mapped outputs from operating, "ISOLATE" the zone first. Refer Section 11.10.4.

From the base display, press:



Where nnnnn is the number of the network zone to be tested.

If nnnnn is a network zone, a list of options is displayed, prompting for the type of test to be performed: Press

- 1: for alarm test (alarm zones)
- 2: for fault test (alarm zones)
- 3: for operate test (ancillary control zones, relays or open collector zones)
- 4: for In-Situ test (alarm zones)
- 5: to abort a test in progress (all zone types)

Then press ACK to initiate the command. The command will be sent to the FIP with the selected zone on it.

The LCD will display the network zone with a message saying "Sending Command". After a brief period the message should change to "Command Accepted", and the test will begin. Refer to Section 11.7 for a description of these and other possible LCD messages.

If an exception occurs at the remote FIP, eg. a test failed, then an exception message may be received indicating the reason. Refer to Section 11.7 for a description of Exception Messages.

11.10.6.3 Notes

- (i) The effect of the test command is dependent upon the receiving FIP type, eg. how the zones will be tested, how other zones/FIPs, etc, are affected by the test, and so forth.
- (ii) A test on a remote zone may be aborted with an abort test command (option 5 from the menu described in Section 11.10.6.2).
- (iii) If the network zone number(s) entered correspond to local zone(s), the LCD/keypad test menu continues as if local zone number(s) had been entered. Refer to Sections 7.5, 8.5, 8.9 and 8.10 for details on local tests.

11.10.6.4 Testing a Range of Network Zones

To test a range of network zones, from the base display press:

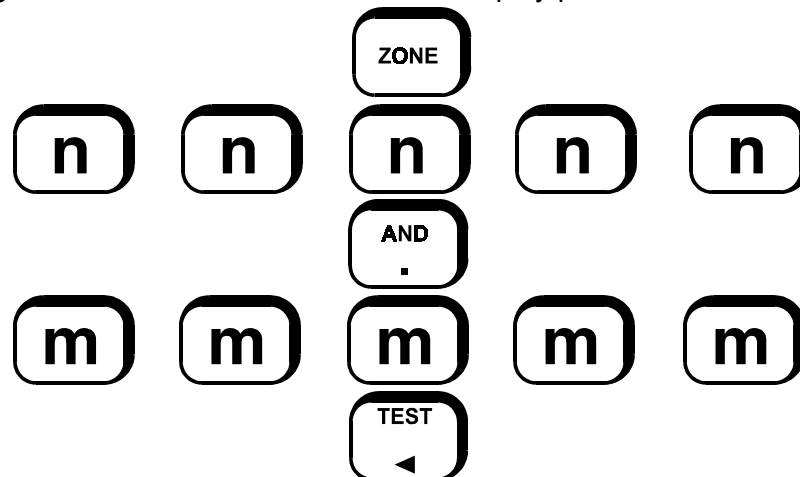

The display will show the selected range of zones, i.e. zone nnnnn to zone mmmmm inclusive, plus a list of options as follows:

- 1: Alarm Test 2: Fault Test 3: Operate Test 4: In-Situ Test
- 5: Abort Test

Press numeric key 1 to 5 to select the test and then press the ACK key to initiate the command.

All zones in the range must be of the same type, i.e. all alarm zones, or all relay zones, etc.

Alarm Test, Fault Test, and In-Situ Test, may be applied only to alarm zones. Operate Test may be applied to relay zones and open collector zones. The abort test command may be applied to any type of zone.

Not all types of FIP support test commands for a range of zones.

11.11 POINT RECALLS & COMMANDS

If any devices on the network support analogue addressable points then they can be accessed from an F3200 panel or NDU (if so programmed). The status of a remote point can be recalled, and commands of isolate, de-isolate, point reset, reset tracking or reset history may be initiated.

The common isolate LED on the operator display panel will flash at 2Hz if there are any isolated points on a remote SID. When the status of a remote SID is being displayed (by recall system faults - Sections 11.6.1 and 11.6.2) the text CmnPtl will be shown on Page 3 of the list if the remote SID has any isolated points. Refer to the Operator Manual for the remote panel to determine the meaning of point values and numbering.

11.11.1 POINT STATUS RECALL

There are four different status displays which may be selected for a point. These are:

1. Point Status; showing Normal, Fault, Alarm, Isol, Node Fault, Pre-Alarm, Maintenance Alert.
2. Analogue values; showing CV, TV, HH, HL.
3. Analogue levels; showing current level (CL), pre-alarm sensitivity (PS), alarm sensitivity (AS).
4. Dirty Detectors; shows the % dirty value as a percentage plus the tracked value (TV), clean air max (CM), the upper tracking limit (UT) and the alarm sensitivity (AS) of the detector.

To recall the status of a specific point, from the base display press:



If the panel does not have a "RELAY/POINT" key then the RELAY key should be used.

Depending on the type of panel, either a menu of options will appear or the operator will be prompted to enter a point number.

If a menu appears, select option 6: Network point, and then enter a point number.

Entering a Point Number

A point number is entered as three numeric values (SID.Responder.Point) with the



key being used to enter the separator. Press the ENTER key after entering 0, 1, 2 or 3 numeric values. If the ENTER key is pressed without entering any numeric values then the first point on the first SID programmed in the local SID list will be recalled.

If a SID number is entered but no responder or point number, then the first point on that SID will be recalled (even if the SID does not appear in the local SID list).

If a SID number and responder number are entered, but no point number, then the first point on the selected responder will be recalled.

The name and number of the selected point will be shown on the display plus a menu of options.

1: Status 2: Analogue Values 3: Analogue levels 4:%Dirty

Press numeric key 1, 2, 3 or 4 for the desired display or press NEXT or PREV keys to step to the next or previous point.

When the status, analogue values or analogue levels or %Dirty of the point is/are being displayed, the



key may be pressed to bring up the menu of:

1: Status 2: Analogue Values 3: Analogue levels 4:%Dirty

Or press numerical keys 1, 2, 3 or 4 to go directly to the relevant menu. At any of the four status displays, the



OR



keys may be pressed to initiate reset or isolate/de-isolate commands to the point. The NEXT or PREV keys may be used to step to the next point.

11.11.2 OFF-NORMAL POINT RECALL

Remote devices on the network may be searched for points with a particular off-normal condition.

From the base display press:   

A menu of options will then be shown. Press numeric key 1 to 6 to select as follows:

1. Status - this allows the status of a specific point to be displayed.
 2. Off Normal - searches for points with any off-normal condition.
 3. Alarms - searches for points in alarm.
 4. Pre-Alarms - searches for points in pre-alarm.
 5. Faults - searches for points in fault.
 6. %Dirty – will search for points that have %Dirty greater than a percentage you will be asked to enter.
- > More - this selects a second menu of options as follows:
1. Isolates - searches for isolated points.
 2. Scan Fail - searches for scan failed points.
 3. Maint Alerts - searches for points in maintenance alert.
 4. Operated - searches for operated points.
 - > More - selects the first menu again.

After the type of search has been selected a prompt is given for the SID.Responder.point to start the search from. If no SID, responder or point are entered then the search will start with the first point on the first SID. If a SID number and no responder/point numbers are entered, then the search starts with the first point on that SID. If a SID number and responder number are entered, then the search starts with the first point on that responder. If a SID, responder and point are all entered, then the search starts at that point.

11.11.3 POINT ISOLATE, DE-ISOLATE OR RESET

From the base display press: 

If the panel does not have a "RELAY/POINT" key, then the RELAY key should be used. Depending on the type of panel, either a menu of options will appear or the operator will be immediately prompted to enter a point number. If a menu appears, select option 6: Network Point and then enter a point number.

Three numeric values for SID.Responder.Point should then be entered, followed by either the:



OR



Isolate/De-Isolate

The name and number of the selected point will be shown along with options of:

1: Isolate 2: De-isolate.

Press numeric key 1 or 2 and the display will show "Sending Command" and after a brief period, "Command Accepted" or an error message.

Reset

The name and number of the selected point will be shown along with options of:

1: Point 2: History 3: Tracking

Press numeric key 1, 2 or 3 and the display will show "Sending Command" and after a brief period, "Command Accepted" or an error message.

THIS PAGE INTENTIONALLY LEFT BLANK

APPENDIX A

COMPATIBLE ACTUATING DEVICES (DETECTORS)

The following detectors are compatible with the F3200 System. The maximum number of detectors per circuit is indicated by the columns 4mA and IS, for Standard and Intrinsically Safe applications respectively. For details on Intrinsically Safe applications refer to the F3200 Installation Manual LT0255.

DETECTORS CERTIFIED WITH F3200 FIP			MAX NO.	
TYPE	DESCRIPTION	BASE	4mA	IS
MD614A	HEAT DETECTOR TYPE A	M614	40	-
MD614C	HEAT DETECTOR TYPE C	M614	40	-
MF614	IONISATION SMOKE DETECTOR	M614	40	-
MR614	PHOTOELECTRIC SMOKE DETECTOR	M614	40	-
MR614T	PHOTOELECTRIC SMOKE DETECTOR	M614	40* ¹	-
MU614	CO FIRE DETECTOR	M614	40	-
T614A	HEAT DETECTOR TYPE A	M614	40	-
T614B	HEAT DETECTOR TYPE B	M614	40	-
T614C	HEAT DETECTOR TYPE C	M614	40	-
T614D	HEAT DETECTOR TYPE D	M614	40	-
MF301Ex	x IONISATION SMOKE DETECTOR	M300	40	40
MR301Ex	x PHOTOELECTRIC SMOKE DETECTOR	M300	40	40
MR301TEEx	x PHOTOELECTRIC SMOKE DETECTOR	M300	40	40
MS302Ex	x INFRA-RED FLAME DETECTOR	M300	40	40
S111	x INFRA-RED FLAME DETECTOR (IS)	-	40	35
S121	x INFRA-RED FLAME DETECTOR (IS)	-	40	35
S131	x INFRA-RED FLAME DETECTOR (IS)	-	40	35
S231i+	x INFRA-RED FLAME DETECTOR (IS)	-	-	11
S231i+	INFRA-RED FLAME DETECTOR AND ZAU401	-	5	5
S231f+	INFRA-RED FLAME DETECTOR AND ZAU401	-	5	-
S261f+	INFRA-RED FLAME DETECTOR	-	40	-
SU0600	15V MCP	-	40	-

*¹ For ambient temp < 30°C. Max Qty is 34 otherwise

Table I MINERVA/THORN Detectors

DETECTORS CERTIFIED WITH F3200 FIP		MAX NO.
TYPE	DESCRIPTION	4mA
DCA-B-60R	HEAT DETECTOR TYPE A	40
DCA-B-90R	HEAT DETECTOR TYPE C	40
DCD-A	HEAT DETECTOR TYPE A WITH YBO – R/4A BASE	40
DCD-C	HEAT DETECTOR TYPE C WITH YBO – R/4A BASE	40
DFE-60B	(DFB-60B) HEAT DETECTOR TYPE B	40
DFE-90D	(DFB-90B) HEAT DETECTOR TYPE D	40
DFJ-60B	HEAT DETECTOR TYPE B WITH YBO – R/4A BASE	40
DFJ-90D	HEAT DETECTOR TYPE D WITH YBO – R/4A BASE	40
SIJ-ASN	IONISATION SMOKE DETECTOR WITH YBO – R/4A BASE	40
SLR-AS	PHOTOELECTRIC SMOKE DETECTOR WITH YBO – R/4A BASE	40
SIF-AM	IONISATION SMOKE DETECTOR	40
SIH-AM	IONISATION SMOKE DETECTOR	40
SLK-A	PHOTOELECTRIC SMOKE DETECTOR	40
SLG-AM	PHOTOELECTRIC SMOKE DETECTOR	40
HF-24A	ULTRAVIOLET FLAME DETECTOR	18
WITH YBC-RL/4AH4, YBF-RL/4AH4 OR YBF-RL/4AH4M BASES		

Table II HOCHIKI Detector Range

DETECTORS CERTIFIED WITH F3200 FIP			MAX NO.	
TYPE	DESCRIPTION	BASE	4mA	IS
B111B #	BEAM SMOKE DETECTOR (NOTE 7)	-	40	0
B21B	BEAM SMOKE DETECTOR	-	1	0
C23B *&	IONISATION SMOKE DETECTOR	Z23	40	0
C23BEx *x	IONISATION SMOKE DETECTOR (IS)	Z23	40	35
C24B	IONISATION SMOKE DETECTOR	*1	40	0
C29B	IONISATION SMOKE DETECTOR	*1	40	0
C29BEX x	IONISATION SMOKE DETECTOR (IS)	Z94C	40	40
DL01191A	BEAM DETECTOR	-	1	-
FW81B	HEAT DETECTOR CABLE FW68, FW105 (IS)	-	1000m	1000m
P24B	PHOTOELECTRIC SMOKE DETECTOR	*1	40	0
P29B	PHOTOELECTRIC SMOKE DETECTOR	*1	36	0
P61B *	PHOTOELECTRIC SMOKE DETECTOR (REV J)	-	40	0
P76B	PHOTOELECTRIC SMOKE DETECTOR NON-LATCHING	Z72	10	0
P136	DUCT SAMPLING UNIT	-	8	-
R23B &	INFRARED FLAME DETECTOR	-	36	0
R24B	DUAL SPECTRUM INFRARED FLAME DETECTOR	-	8	0
R24BEX +x	DUAL SPECTRUM INFRARED FLAME DETECTOR (IS)	-	8	7
T54B +x#	PROBE TYPE E HEAT DETECTOR (IS OR FLAMEPROOF)	-	40	40
T56B x	HEAT DETECTOR TYPES A, B, C, D (IS WITH Z55, Z56N or Z500N BASE)	*1	40	40
V41B +x#	ULTRAVIOLET FLAME DETECTOR	-	40	40
V42B +x#	ULTRAVIOLET FLAME DETECTOR SLAVE	-	N/A	N/A
V44B +x#	ULTRAVIOLET FLAME DETECTOR	-	40	40
-	SHORT CIRCUIT DEVICE	-	40	40

*1 = Z54, Z54 MK2, Z55B, Z56, Z500 BASES

Table III
OLSEN Detector Range

DETECTORS CERTIFIED WITH F3200 FIP			MAX NO.	
TYPE	DESCRIPTION	4mA		
SERIES 60	APOLLO HEAT DETECTOR TYPES A, B, C, D	40		
SERIES 60	APOLLO PHOTOELECTRIC SMOKE DETECTOR	40		
SERIES 60	APOLLO IONISATION SMOKE DETECTOR	40		
ALL WITH 45681-200 BASES				
MK VIII *	FLAMEGUARD HEAT DETECTOR TYPE A	22		
MK VIII *	FLAMEGUARD HEAT DETECTOR TYPE C	11		
MK5, MK6 *	INTERTEC HEAT DETECTOR TYPES A, B, C, D	22		
(NOTE 9) DETECTOR HAS INTEGRAL LED & TERMINALS				

Table IV
OTHER Detectors

SIMPLEX RANGE			MAX NUMBER WITH EOL	
TYPE	DESCRIPTION	Iq uA		
4098-9618EA	Type A Heat Detector	100	40	
4098-9619EA	Type B Heat Detector	100	40	
4098-9621EA	Type D Heat Detector	100	40	
4098-9601EA	Photoelectric Smoke Detector	100	40	
4098-9603EA	Ionisation Smoke Detector	100	40	

All with Simplex 4098-9788EA base.

Table V
SIMPLEX Detectors

ACTUATING DEVICE COMPATIBILITY NOTES

- 1) The maximum number of detectors per AZC allowed by the standard is 40.
- 2) Those detectors shown in brackets have the same characteristics as the current models.
- 3) Detectors indicated by a "x" may be used in **INTRINSICALLY SAFE AREAS** in conjunction with approved and compatible, intrinsically safe adaptors. The number allowed in a particular circuit may be less than the maximum shown. Refer to the Installation Manual for details.

V41/42/44B detectors have flameproof enclosures.
- 4) Detectors indicated by a "+", which are used in **HOSTILE CLIMATIC ENVIRONMENTS**, may be directly connected to the panel, if they are not required to be intrinsically safe.
- 5) Detectors indicated by a "*", are not current models and should not be used for new installations.
- 6) Detectors indicated by an "&", normally use an incandescent lamp which will have a low intensity when used in mode 1.

The lamp can be replaced with an LED kit - contact supplier.
- 7) The B111B beam and V41B/V42B/V44B flame detectors require power from the fused +24 VDC supply.
- 8) Hard Contact devices are indicated by a #. Where an AZC has only hard contact devices circuit resistance must be less than 150 Ohms (i.e. reduce line voltage to less than 2.5V), to distinguish instant alarms (B1) from alarms (B2) (e.g. to override AVF).
- 9) The Intertec detectors require a series diode to be fitted for compatibility. Consult manufacturer for detail.
- 10) The Olsen FW81B code for fire wire has been replaced by FW followed by the temperature rating in °C, eg. FW68, FW105. Only FW68 is currently approved and listed.

THIS PAGE INTENTIONALLY LEFT BLANK